

Service
Service
Service



Service Manual



x.v.Colour



TABLE OF CONTENTS

	Chapter
Location of PCB Boards	1-2
Versions Variation	1-2
Specifications	1-3
Measurement Setup	1-4
Service Aids	1-5
ESD & Safety Instruction	1-6
Lead-free soldering Information	1-7
Setting procedure & Repair Instructions.....	2
Disassembly Instructions & Service positions	3
Block & Wiring Diagram	4
Quick Start Guide	5
VFD+VOL+USB+MP3 PCB	6
MAIN PCB.....	7
POWER PCB	8
BD PCB.....	9
TOUCH PCB.....	10
Mechanical Exploded view	11
Revision List	12

© Copyright 2010 Philips Consumer Electronics B.V. Eindhoven, The Netherlands
 All rights reserved. No part of this publication may be reproduced, stored in a retrieval system or transmitted, in any form or by any means, electronic, mechanical, photocopying, or otherwise without the prior permission of Philips.

Published by RY_HY1125 Service Audio Printed in The Netherlands Subject to modification

GB 3139 785 35463

Version 1.3



PHILIPS

LOCATION OF PCB BOARDS

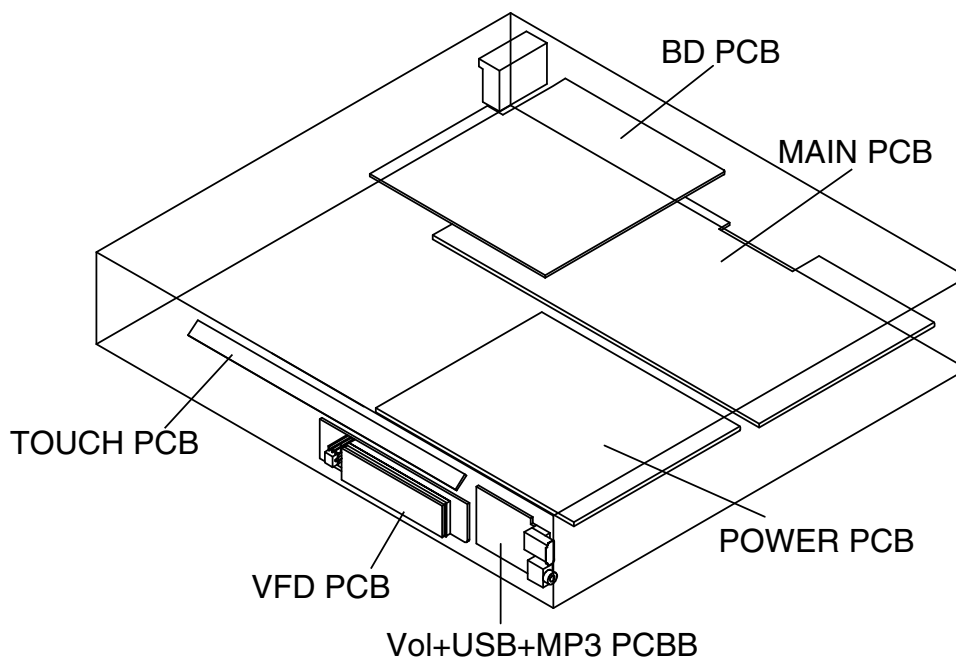

VERSION VARIATION:

Type/Versions	HTS3560				
	/12	/51	/98	/78	X78
Output Power - 1000W(800W for /78)	X	X	X	X	X
Voltage (220~240V)	X	X			
Voltage (110-127V/220-240V)			X	X	X
AUX/MP3	X	X	X	X	X

SERVICE SCENARIO MATRIX:

Type/Versions	HTS3560				
	/12	/51	/98	/78	X78
Board in used					
Main Board	C	C	C	C	C
Power Board	C	C	C	C	C
VFD+VOL+USB+MP3 Board	C	C	C	C	C
BD Board	Bd	Bd	Bd	Bd	Bd
Touch Board	C	C	C	C	C

*C = Component Level Repair

*Bd = Board Level Replacement

SPECIFICATIONS **(Red colour for /98/78, Green colour for/78)**

Playback media

BD-Video, DVD-Video, DVD+R/+RW, DVD-R/-RW, DVD+R/-R DL, CD-R/CDRW, Audio CD, Video CD/SVCD, PictureCD, MP3-CD, WMA-CD, DivX (Ultra)-CD, USB flash drive.

File Format

Audio mp3, .wma
Videoavi, .divx, .mkv, .wmv
Picturejpg, .gif, .png

Amplifier

Total output power 1000 W RMS (30%THD)
Total output power 800 W RMS (10%THD)
Frequency response 20 Hz-20 kHz /±3dB
Signal-to-noise ratio > 65 dB (CCIR) /(A-weighted)
Input sensitivity:
AUX 500 mV
MP3 LINK 250 mV

Video

Signal system PAL / NTSC
HDMI output 480i/576i, 480p/576p, 720p, 1080i, 1080p

Audio

Sampling frequency:
MP3 32 kHz, 44.1 kHz, 48 kHz
WMA 44.1 kHz, 48 kHz
Constant bit rate:
MP3 112 kbps - 320 kbps
WMA 48 kbps - 192 kbps

Radio

Tuning range FM 87.5-108 MHz (50 kHz)
Signal-to-noise ratio FM 55 dB
Frequency response FM 180 Hz-12.5 kHz/ ±3dB

USB

Compatibility Hi-Speed USB (2.0)
Class support UMS (USB Mass Storage Class)
File system FAT16, FAT32, NTFS
Maximum memory support < 160GB

Main Unit

Power supply 220-240V; ~50 Hz
Power supply 110-127V/220-240V; ~50-60 Hz
Power consumption 100 W
Standby power consumption ≤ 0.9 W
Dimensions (WxHxD) 360 x 58 x 351 (mm)
Weight 3.22 kg

Speakers

System full range satellite
Speaker impedance 4 ohm (center), 4ohm (Front/Rear)
Speaker drivers 1 x 3" full range
Frequency response 150 Hz-20 kHz

Dimensions (WxHxD)

Center 161x 92 x 95 (mm)
Speaker 95 x161 x 87(mm)
Weight:
Center 0.77 kg
Speaker 0.56 kg/each
Cable length:
Center 3 m
Front/Rear 4 m

Subwoofer

Impedance 4 ohm
Speaker drivers 165 mm (6.5") woofer
Frequency response 40 Hz-150 Hz
Dimensions (WxHxD) 123x309x369(mm)
Weight 3.81 kg
Cable length 4 m

Laser specification

Laser Type (Diode) InGaN/AlGaIn (BD)
..... InGaAlP (DVD), AlGaAs (CD)
Wave length 405 +5nm/-5nm (BD)
..... 650+13nm/-10nm (DVD)
..... 790 +15nm/-15nm(CD)
Output power (Max. ratings) 20mW(BD), 7mW (DVD/CD)

Specifications subject to change without prior notice.

MEASUREMENT SETUP

Tuner FM

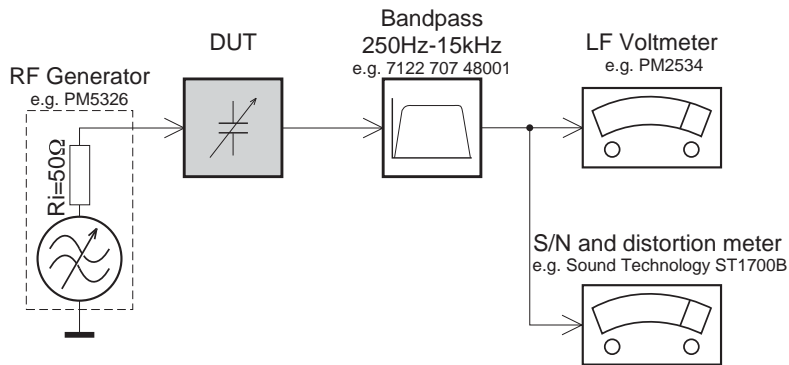

Use a bandpass filter to eliminate hum (50Hz, 100Hz) and disturbance from the pilotone (19kHz, 38kHz).

CD

Use Audio Signal Disc SBC429 4822 397 30184
(replaces test disc 3)

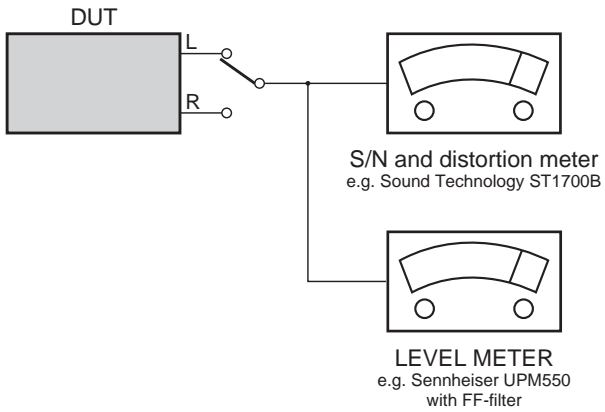

SERVICE AIDS

Service Tools:

Universal Torx driver holder	4822 395 91019
Torx bit T10 150mm	4822 395 50456
Torx driver set T6-T20	4822 395 50145
Torx driver T10 extended	4822 395 50423

Compact Disc:

SBC426/426A Test disc 5 + 5A	4822 397 30096
SBC442 Audio Burn-in test disc 1kHz	4822 397 30155
SBC429 Audio Signals disc	4822 397 30184
Dolby Pro-logic Test Disc	4822 395 10216

HANDLING CHIP COMPONENTS

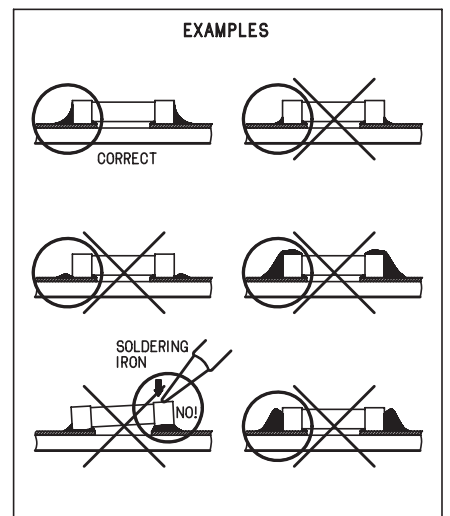
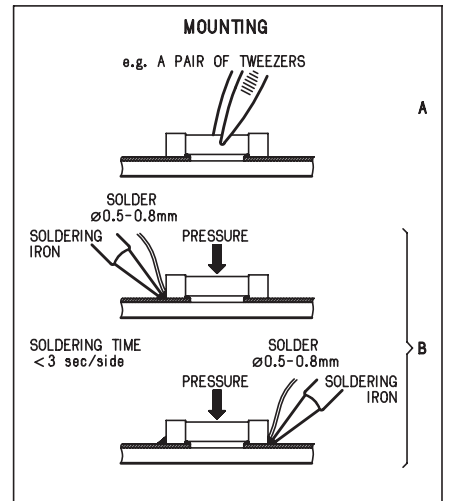
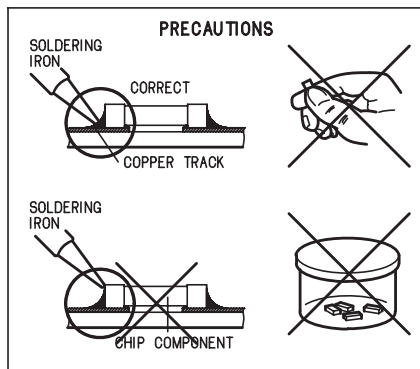
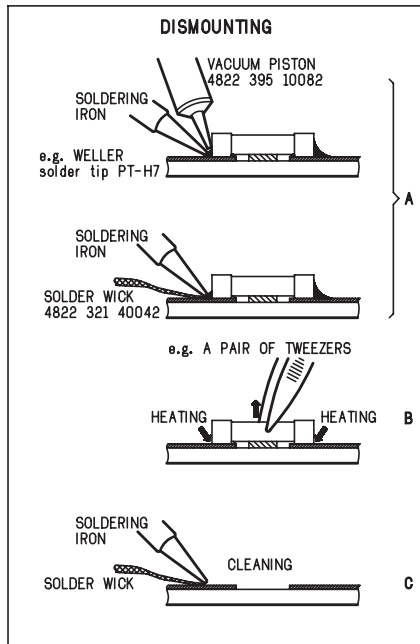
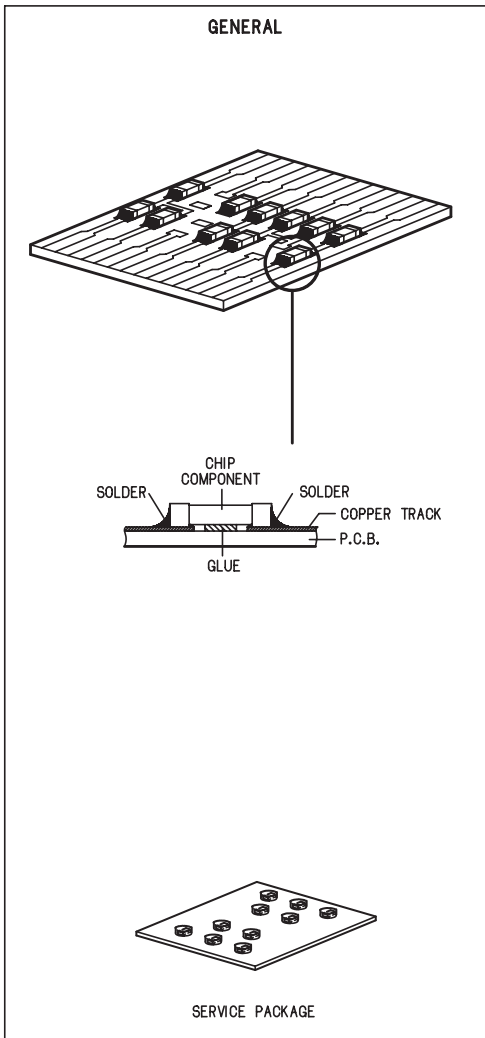

ESD**(GB) WARNING**

All ICs and many other semi-conductors are susceptible to electrostatic discharges (ESD). Careless handling during repair can reduce life drastically.

When repairing, make sure that you are connected with the same potential as the mass of the set via a wrist wrap with resistance. Keep components and tools also at this potential.

(F) ATTENTION

Tous les IC et beaucoup d'autres semi-conducteurs sont sensibles aux décharges statiques (ESD).

Leur longévité pourrait être considérablement écourtée par le fait qu'aucune précaution n'est prise à leur manipulation.

Lors de réparations, s'assurer de bien être relié au même potentiel que la masse de l'appareil et enfiler le bracelet serti d'une résistance de sécurité.

Veiller à ce que les composants ainsi que les outils que l'on utilise soient également à ce potentiel.

(D) WARNUNG

Alle ICs und viele andere Halbleiter sind empfindlich gegenüber elektrostatischen Entladungen (ESD).

Unsorgfältige Behandlung im Reparaturfall kann die Lebensdauer drastisch reduzieren. Veranlassen Sie, dass Sie im Reparaturfall über ein Pulsarmband mit Widerstand verbunden sind mit dem gleichen Potential wie die Masse des Gerätes.

Bauteile und Hilfsmittel auch auf dieses gleiche Potential halten.

(NL) WAARSCHUWING

Alle IC's en vele andere halfgeleiders zijn gevoelig voor electrostatische ontladingen (ESD).

Onzorgvuldig behandelen tijdens reparatie kan de levensduur drastisch doen verminderen. Zorg ervoor dat u tijdens reparatie via een polsband met weerstand verbonden bent met hetzelfde potentiaal als de massa van het apparaat.

Houd componenten en hulpmiddelen ook op hetzelfde potentiaal.

(I) AVVERTIMENTO

Tutti IC e parecchi semi-conduttori sono sensibili alle scariche statiche (ESD).

La loro longevità potrebbe essere fortemente ridatta in caso di non osservazione della più grande cauzione alla loro manipolazione. Durante le riparazioni occorre quindi essere collegato allo stesso potenziale che quello della massa dell'apparecchio tramite un braccialetto a resistenza.

Assicurarsi che i componenti e anche gli utensili con quali si lavora siano anche a questo potenziale.

(GB) ESD PROTECTION EQUIPMENT

Complete Kit ESD3 (small tablemat, wristband, connection box, estention cable and earth cable 4822 310 10671
Wristband tester 4822 344 13999

(GB)

Safety regulations require that the set be restored to its original condition and that parts which are identical with those specified, be used.

Safety components are marked by the symbol Δ .

(NL)

Veiligheidsbepalingen vereisen, dat het apparaat bij reparatie in zijn oorspronkelijke toestand wordt teruggebracht en dat onderdelen, identiek aan de gespecificeerde, worden toegepast.

De Veiligheidsonderdelen zijn aangeduid met het symbol Δ .

(F)

Les normes de sécurité exigent que l'appareil soit remis à l'état d'origine et que soient utilisés les pièces de rechange identiques à celles spécifiées.

Less composants de sécurité sont marqués Δ .

(D)

Bei jeder Reparatur sind die geltenden Sicherheitsvorschriften zu beachten. Der Originalzustand des Geräts darf nicht verändert werden; für Reparaturen sind Original-Ersatzteile zu verwenden.

Sicherheitsbauteile sind durch das Symbol Δ markiert.

(I)

Le norme di sicurezza esigono che l'apparecchio venga rimesso nelle condizioni originali e che siano utilizzati i pezzi di ricambio identici a quelli specificati.

Componenti di sicurezza sono marcati con Δ .

(GB)

After servicing and before returning set to customer perform a leakage current measurement test from all exposed metal parts to earth ground to assure no shock hazard exist, The leakage current must not exceed 0.5mA.

**(GB) Warning !**

Invisible laser radiation when open.
Avoid direct exposure to beam.

(S) Varning !

Osynlig laserstrålning när apparaten är öppnad och spärren är urkopplad. Betrakta ej strålen.

(SF) Varoitus !

Avatussa laitteessa ja suojalukituksen ohitettaessa olet alltiina näkymättömälle laserisäteilylle. Älä katso säteeseen!

(DK) Advarse !

Usynlig laserstråling ved åbning når sikkerhedsafbrydere er ude af funktion. Undgå udsættelse for stråling.

(F)

"Pour votre sécurité, ces documents doivent être utilisés par des spécialistes agréés, seuls habilités à réparer votre appareil en panne".

Pb(Lead) Free Solder

When soldering, be sure to use the pb free solder.

IDENTIFICATION:

Regardless of special logo (not always indicated) 

one must treat all sets from **1 Jan 2005** onwards, according next rules:

Important note: In fact also products of year 2004 must be treated in this way as long as you avoid mixing solder-alloys (leaded/ lead-free). So best to always use SAC305 and the higher temperatures belong to this.

Due to lead-free technology some rules have to be respected by the workshop during a repair:

- Use only lead-free solder alloy Philips SAC305 with order code 0622 149 00106. If lead-free solder-paste is required, please contact the manufacturer of your solder-equipment. In general use of solder-paste within workshops should be avoided because paste is not easy to store and to handle.
- Use only adequate solder tools applicable for lead-free solder alloy. The solder tool must be able
 - To reach at least a solder-temperature of 400°C,
 - To stabilize the adjusted temperature at the solder-tip
 - To exchange solder-tips for different applications.
- Adjust your solder tool so that a temperature around 360°C – 380°C is reached and stabilized at the solder joint. Heating-time of the solder-joint should not exceed ~ 4 sec. Avoid temperatures above 400°C otherwise wear-out of tips will rise drastically and flux-fluid will be destroyed. To avoid wear-out of tips switch off unused equipment, or reduce heat.
- Mix of lead-free solder alloy / parts with leaded solder alloy / parts is possible but PHILIPS recommends strongly to avoid mixed solder alloy types (leaded and lead-free).

If one cannot avoid or does not know whether product is lead-free, clean carefully the solder-joint from old solder alloy and re-solder with new solder alloy (SAC305).

- Use only original spare-parts listed in the Service-Manuals. Not listed standard-material (commodities) has to be purchased at external companies.
- Special information for BGA-ICs:
 - Always use the 12nc-recognizable soldering temperature profile of the specific BGA (for de-soldering always use the lead-free temperature profile, in case of doubt)
 - Lead free BGA-ICs will be delivered in so-called 'dry-packaging' (sealed pack including a silica gel pack) to protect the IC against moisture. After opening,

dependent of MSL-level seen on indicator-label in the bag, the BGA-IC possibly still has to be baked dry. (MSL=Moisture Sensitivity Level). This will be communicated via AYS-website.

Do not re-use BGAs at all.

- For sets produced before 1.1.2005 (except products of 2004), containing leaded solder-alloy and components, all needed spare-parts will be available till the end of the service-period. For repair of such sets nothing changes.
- On our website www.atyourservice.ce.Philips.com you find more information to:
 - BGA-de-/soldering (+ baking instructions)
 - Heating-profiles of BGAs and other ICs used in Philips-sets

You will find this and more technical information within the "magazine", chapter "workshop news".

For additional questions please contact your local repair-helpdesk.

System , Region Code , etc. Setting Prochure

1)Restore factory setting

- Press "⬆" <Home> button on R/C.
- Select <SETUP>, then press "OK" button on R/C.
- Select <Advanced setup> ,then press < OK > button on R/C.
- Select <Restore default settings>,then press <OK> to confirm.

2)Password change

- Press "⬆" <Home> button on R/C.
 - Select <SETUP>, then press "OK" button on R/C.
 - Select <preference setup>, then press <OK> button on R/C.
 - Select <Change Password> <Confirm>, then press <OK> button on R/C.
- "0000" is default password supplied.

3)Trade mode

- In open model,press "⬆" <Home> button on R/C.
- Press "2" "5" "9" on R/C,VFD will display "TRA ON" or "TRA OFF".

4)Check software version

- Press "⬆" <Home> button on R/C
- Select <Setup>, then press <OK> button on R/C.
- Select <Advanced Setup> <Version Info.>,then press <OK> button on R/C.
- TV will show message as follow:

Model:HTS3560/12/51/98/78/x78
Version:
System SW:29.00
Subsystem SW:28-00-00-00
Ethernet MAC:00-25-D1-02-25-D4
<http://www.philips.com/support>

Close

- Select <Close> on the version display screen and press <OK> button to exit .

5) Upgrading new software

Method 1: Update software from a USB storage device or CD-R

- Create a folder named "UPG" in your CD-R or USB storage device, and Copy the latest upgrading software into the folder.
- Insert the CD-R program disc or connect the USB storage device to the home theater.
- Press "⬆" <Home> button on R/C, and select <Setup>.
- Select <Advance Setup> <Software Update> <USB>.
- TV will show message as follow:

Now searching for upgrade software!
Please wait...!

Software updates for this player have been found. Do you want to upgrade?

Cancel

Start

- Select <Start>, press <OK> button on R/C.

Software upgrade will take 5 minutes

Do not switch off!

Package version: 000029.0

Software BE	80%
Software FE	Completed
Software MCU1:	
Software Dock:	
Software MCU3:	

Software upgrade will take 5 minutes

Do not switch off!

Package version: 000029.0

Software BE	Completed
Software FE	Completed
Software MCU1:	Not started
Software Dock:	2%
Software MCU3:	Not started

Software upgrade will take 5 minutes

Do not switch off!

Package version: 000029.0

Software BE	Completed
Software FE	Completed
Software MCU1:	1%
Software Dock:	Failed
Software MCU3:	

- The set will shut down automatically when the software upgrade is completed.

Method 2: Update software from the network

Note: To check for new updates, compare the current software version of your home theater with the latest software version (if available) on the Philips web site, and for BD-Live application and software update, make sure that the network router has access to the Internet and the firewall is disabled.

- The "LAN" jack at the back panel of the set must be connect to the network router via network cable and the set connect to TV, Prepare the connection as shown follow:

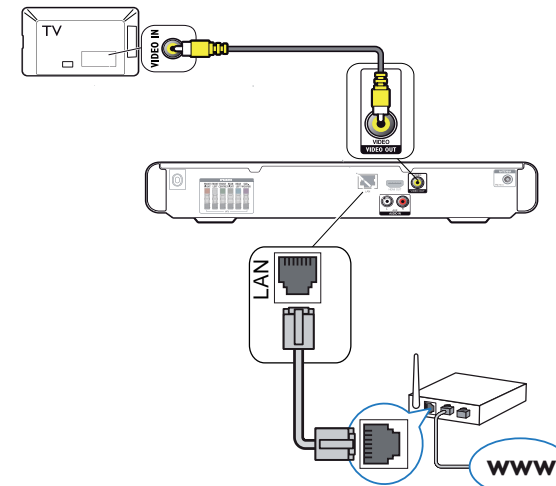

- Press "⬆" <Home> button on R/C, and select <Setup>.
- Select <Advance Setup> <Software Update> <Network>.
- TV will show message as follow:

Now searching for upgrade software!
Please wait...!

Software updates for this player have been found. Do you want to upgrade?

Cancel

Start

- Select <Start>, press <OK> button on R/C.

Software upgrade will take 5 minutes

Do not switch off!

Package version: 000029.0

Software BE	80%
Software FE	Completed
Software MCU1:	
Software Dock:	
Software MCU3:	

Software upgrade will take 5 minutes	
Do not switch off!	
Package version: 000029.0	
Software BE	Completed
Software FE	Completed
Software MCU1:	Not started
Software Dock:	2%
Software MCU3:	Not started

c) Assembly Blu-ray Loader to “J802”, “J900”, “J906” on the top of BD Board as shown below.

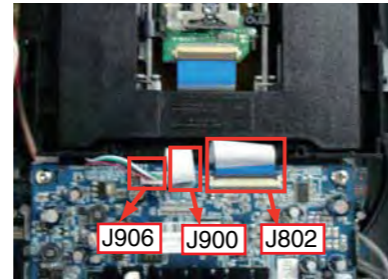

d) Remove soldered joint on the ESD protection points.

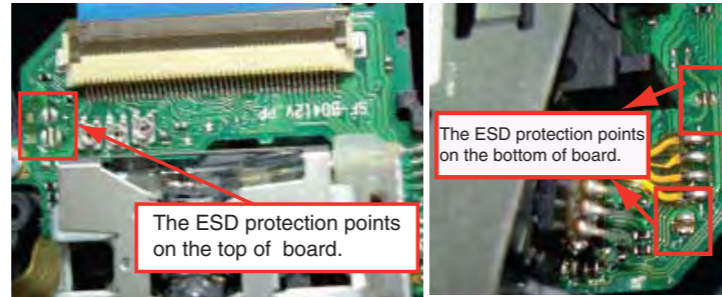

Top side view of OPU

Bottom side view of OPU

Note: The 2 ESD protection points on any one side must be soldered if

- o the Blu-ray Loader is OK and needs to be disconnected from connector J802, J900 and J906 of the BD Board.
- o the defective Blu-ray Loader is needed to be send back to supplier for failure analysis and to support backcharging evidence.

7)BD board and Blu-ray Loader OPU matching procedure

Note: This procedure must be performed whenever the defective Blu-ray Loader or BD Board has been replaced .

- Assembly Blu-ray Loader to BD Board.
- Remove soldered joint on the ESD protection points.
- Power on the set , press “” <Home> button and input “5” “1” “7” “7” on R/C.
- Go into OSD Select mode and select item [5] ,then press <OK> button on R/C as shown follow:

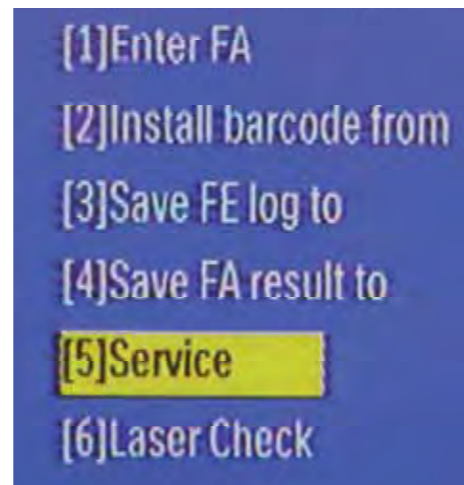

e) Insert empty USB device of MSC type and press <OK> button with R/C as shown follow:

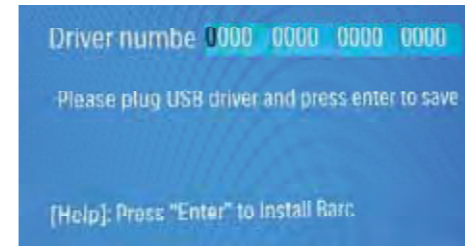

f) Using “ ” buttons on R/C input the 6-digits OPU data given on the 1D barcode (see label on the Loader) with the on-screen selection and press <OK> button to save each digit entered as shown follow:

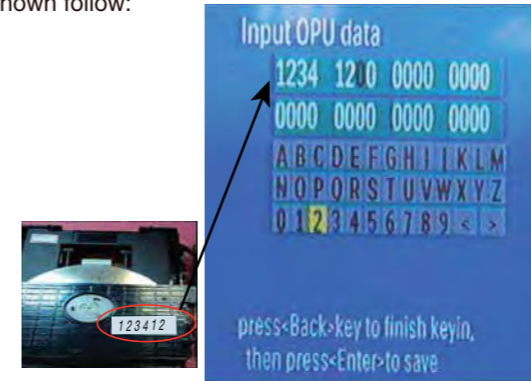

g) Press <Back> followed by <OK> button to finish OPU matching and “” <Home> button to exit.

h) Repeat step c) and select item [6] ,then press <OK> button on R/C as shown follow:

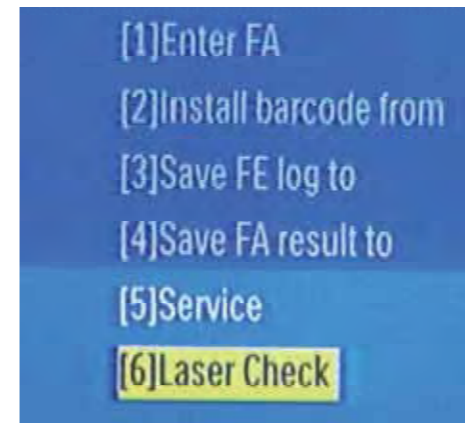

i)Wait laser check to complete,press <stop> button to exit as shown follow:

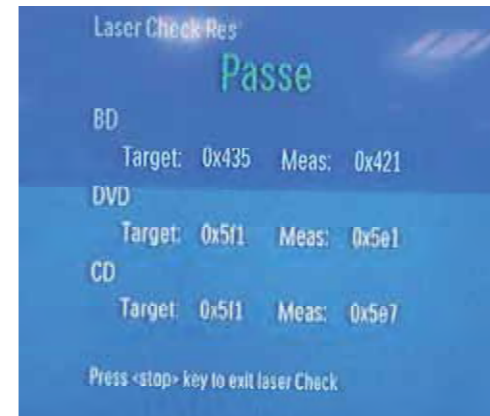

j) If laser check fails press “” <Home> button and repeat OPU matching procedure.

8)DVD Region Code Change

a) In open mode, press “8” “6” “8” “9” “3” “1” on R/C,then input desired number to change region code:

- 1 USA
- 2 EU
- 3 APAC
- 4 Australia ,NZ, Latam
- 5 Russia ,India
- 6 China

9) Produce to change Tuner grid(only for /98/51 version)

In some countries, you can switch the FM tuning grid between 50 kHz and 100 kHz. Changing the tuning grid erases all preset radio stations.

- Press<radio> button on R/C
 - Press <Stop> button on R/C.
 - Press and hold <Play> until (50 kHz) or (100 kHz) is displayed.
- Note: repeaing the same action will toggle back to it previous tunning grid setting.

CAUTION!

This information is confidential and may not be distributed.Only a qualified service person should reprogram the Region Code.

f) The set will shut down automatically when the software upgrade is completed.

6)How to replace the defective Blu-ray Loader

- Remove the defective Blu-ray Loader.
- Remove the shield cover at the top of Blu-ray Loader as shown below.

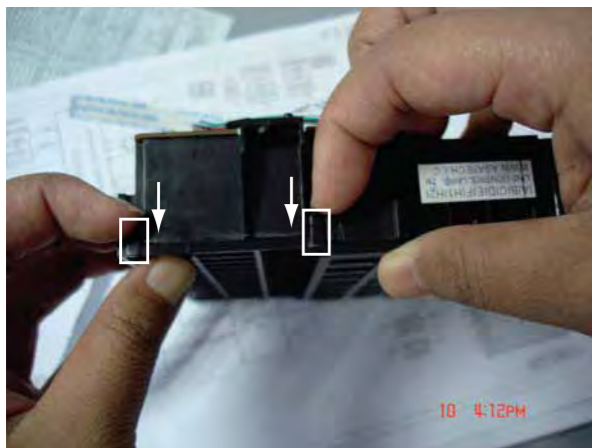

MAIN UNIT REPAIR CHART

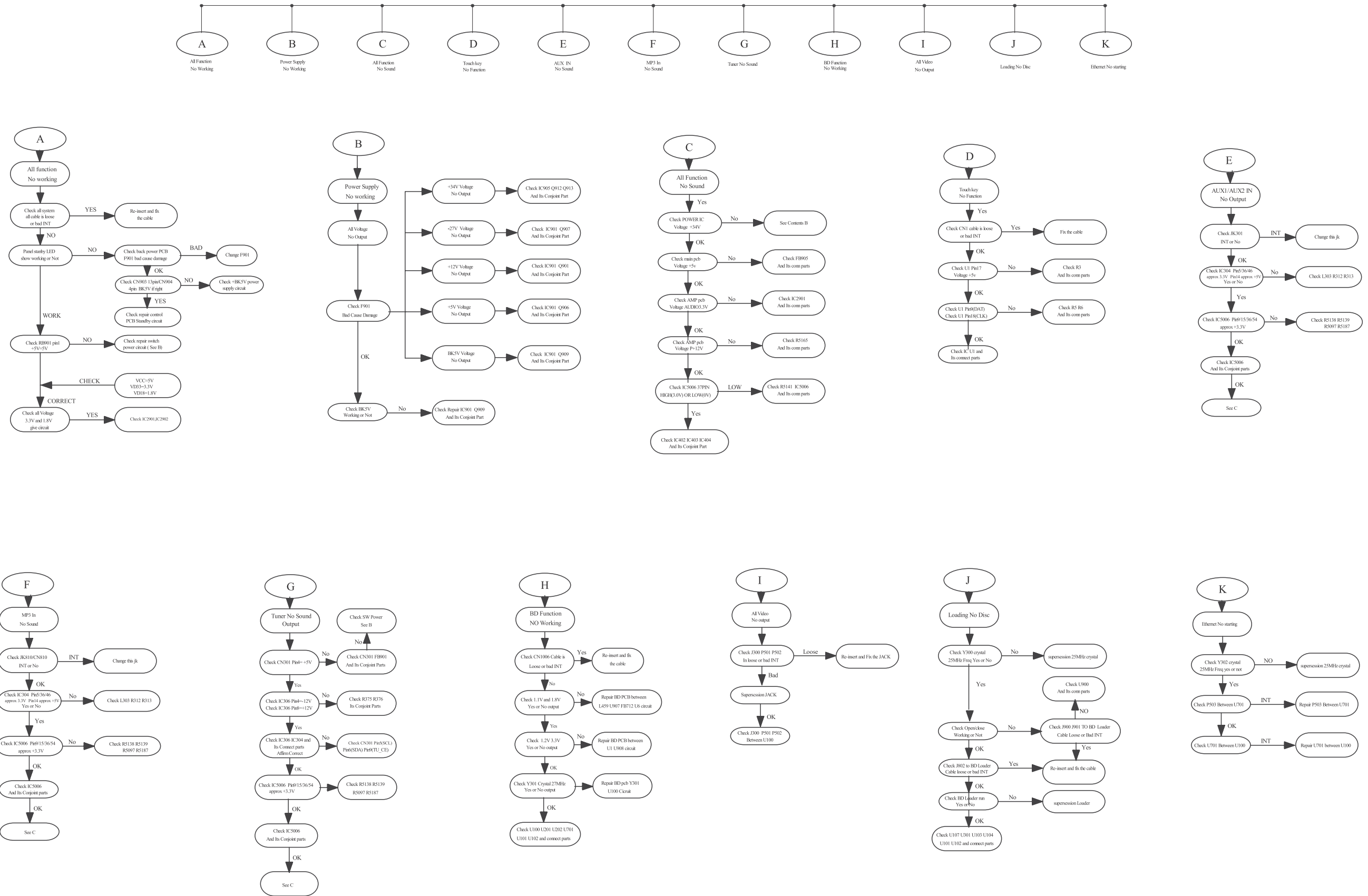

DISASSEMBLY INSTRUCTIONS

Dismantling of the Top & Front Panel Assemble

- 1) Open the BD Tray by using the Open/Close Button while the Set is ON and disconnect the mains supply after removing the Tray Cover.
Note: If this is not possible, the BD Tray has to be open manually.
Take a mini screw driver about 2mm diameter and make a marking 24mm from the tip as shown in figure 2 . Place the set on its side, insert the mini screw driver till the marking and slide it towards the left as shown in figure 1 until the Tray moves out of the Front Panel.
- 2) Return the set to its upright position and remove the Tray Cover as shown in Figure 3 and close the tray manually by pushing it back in.

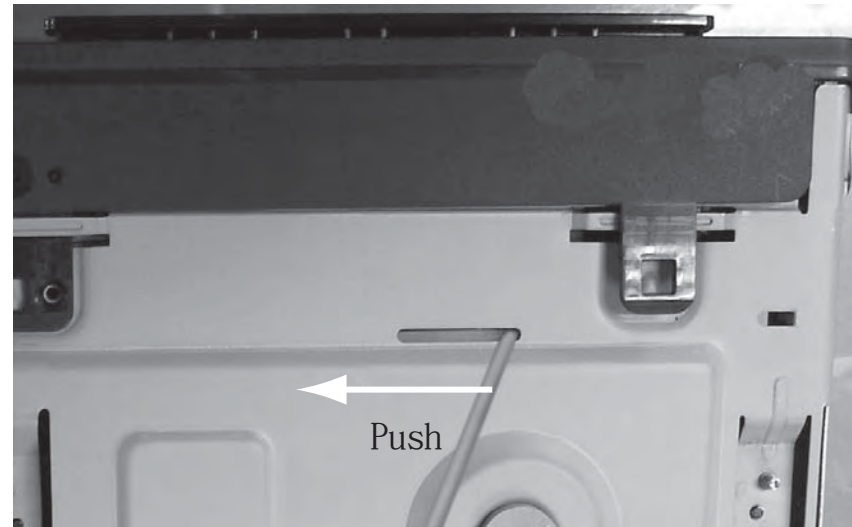

Figure 1

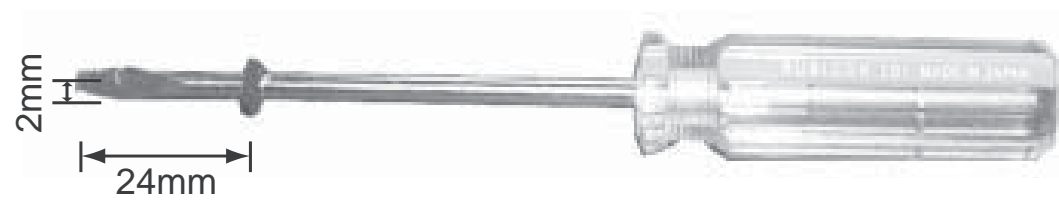

Figure 2

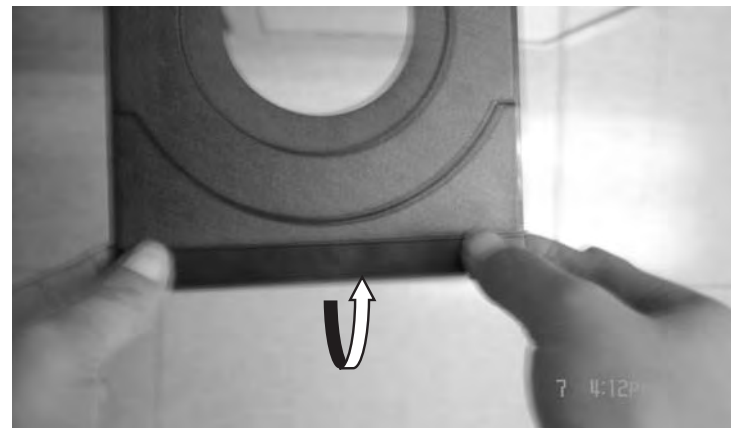

Figure 3

- 3) Loosen 6 screws and remove the Top Cover by lifting the rear portion upwards before sliding it out towards the rear.
 - 4 screws "A" at the back panel as shown in figure 4.
 - 1 screw "B" each on the left & right side as shown in figure 5.
- 4) Remove Volume KNOB as shown in figure 6 and using sleeve to loosen screw as shown in figure 7 & 8 to remove the front panel.

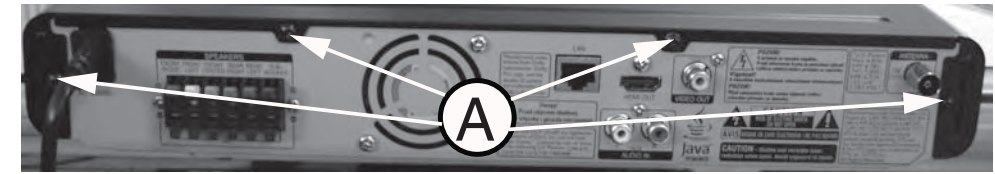

Figure 4

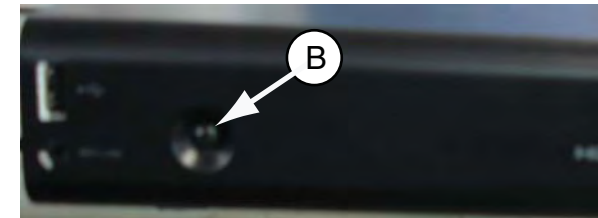

Figure 5

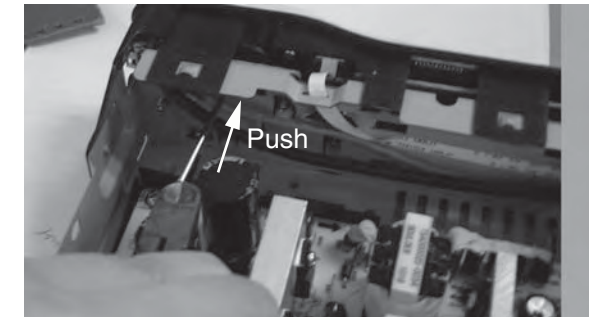

Figure 6



Figure 7

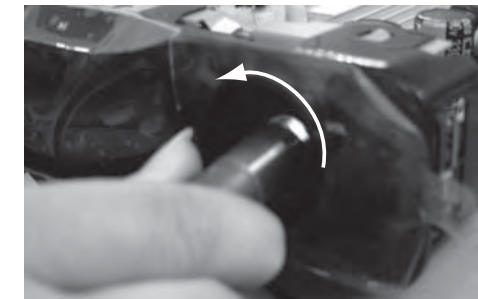

Figure 8

Dismantling of the BD Module

- 1) Loosen 4 screws "C" at the BD Module as shown in figure 9.

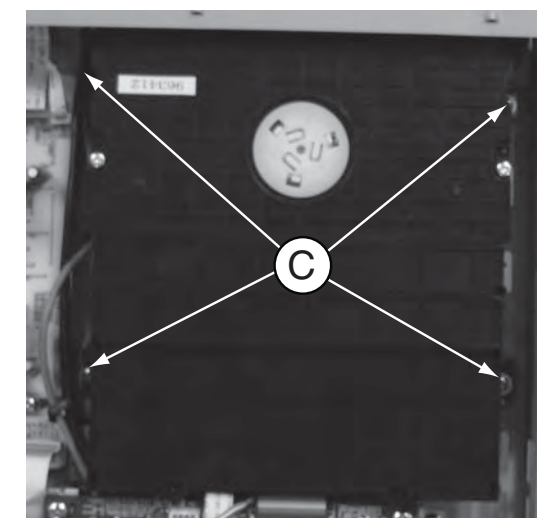

Figure 9

Dismantling of the VFD+VOL+USB+MP3 Board

- 1) Loosen 6 screws "D" on the top of VFD+VOL+USB+MP3 Board as shown in figure 10.

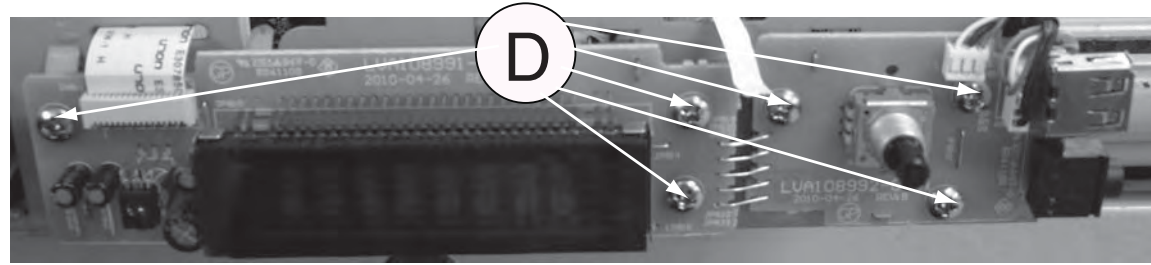

Figure 10

Dismantling of the TOUCH Board

- 1) Loosen 4 screws "E" on the top of touch Board bracket as shown in figure 11.



Figure 11

Dismantling of the BD Board

- 1) Loosen 4 screws "F" on the top of BD Board as shown in figure 12
- 2) At the back panel, loosen 2 screws "G" as shown in figure 13

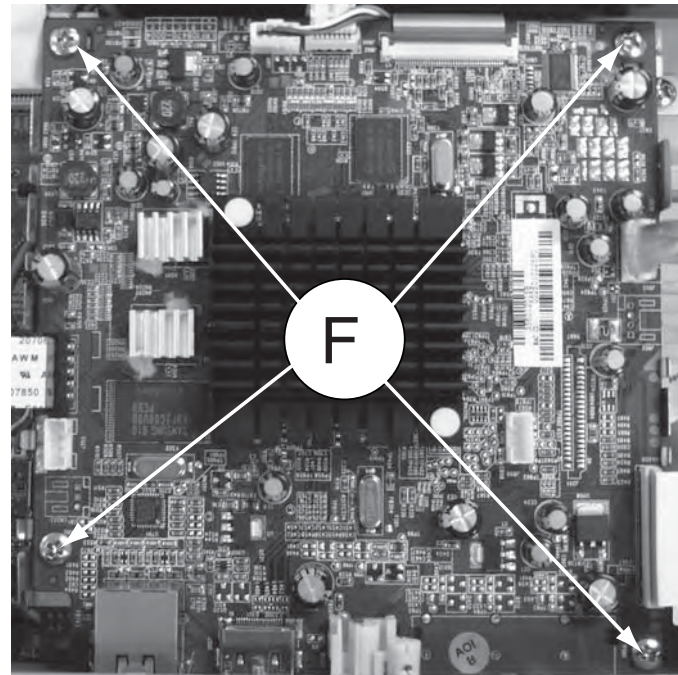

Figure 12

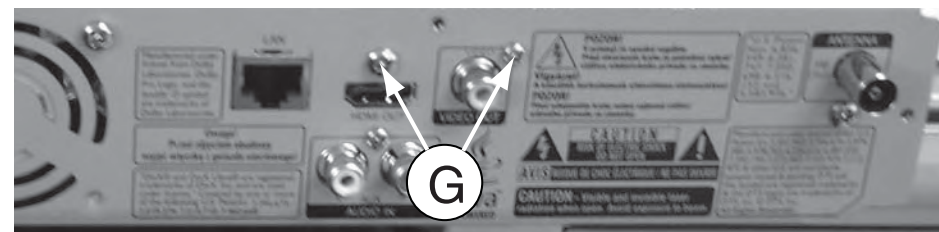

Figure 13

Dismantling of the MAIN Board

- 1) Loosen 3 screws "H" on the top of MAIN Board as shown in figure 14.
- 2) Loosen 3 screws "I" at the back panel as shown in figure 15.

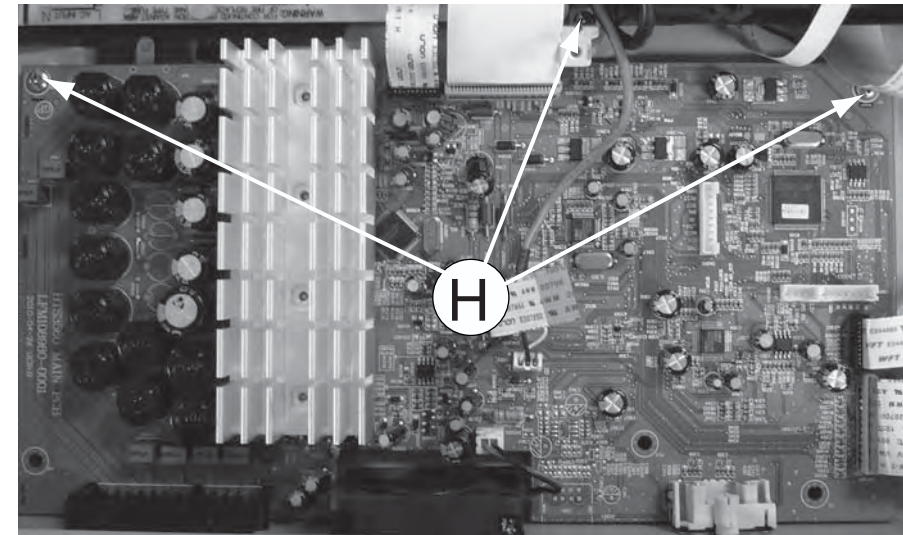

Figure 14

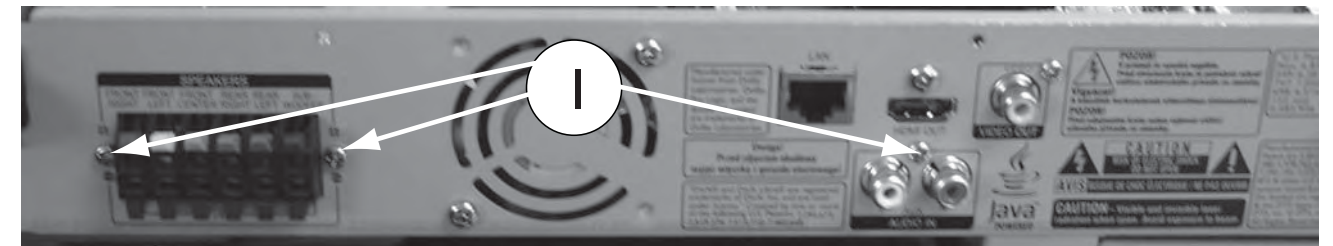

Figure 15

Dismantling of the POWER Board

- 1) Loosen 5 screws "J" on the top of Power Board as shown in figure 16.

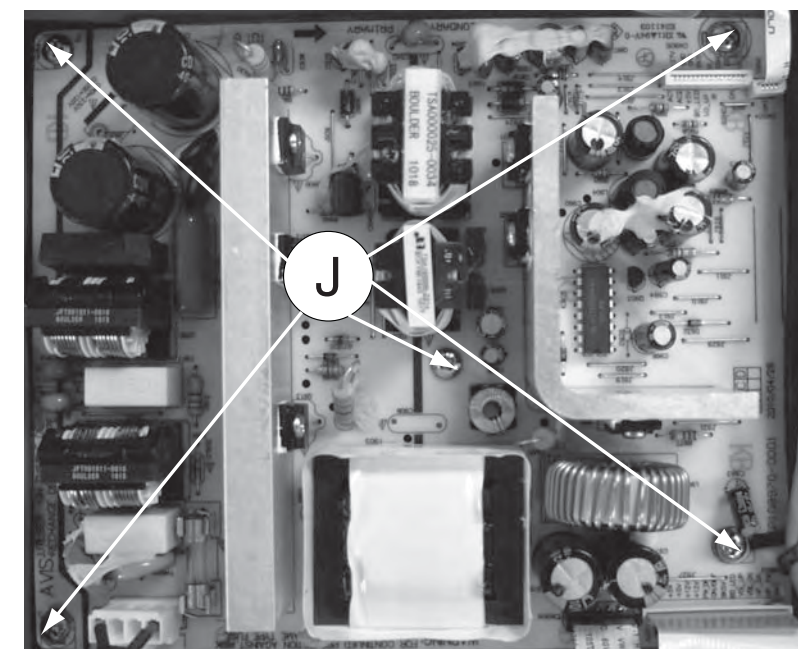
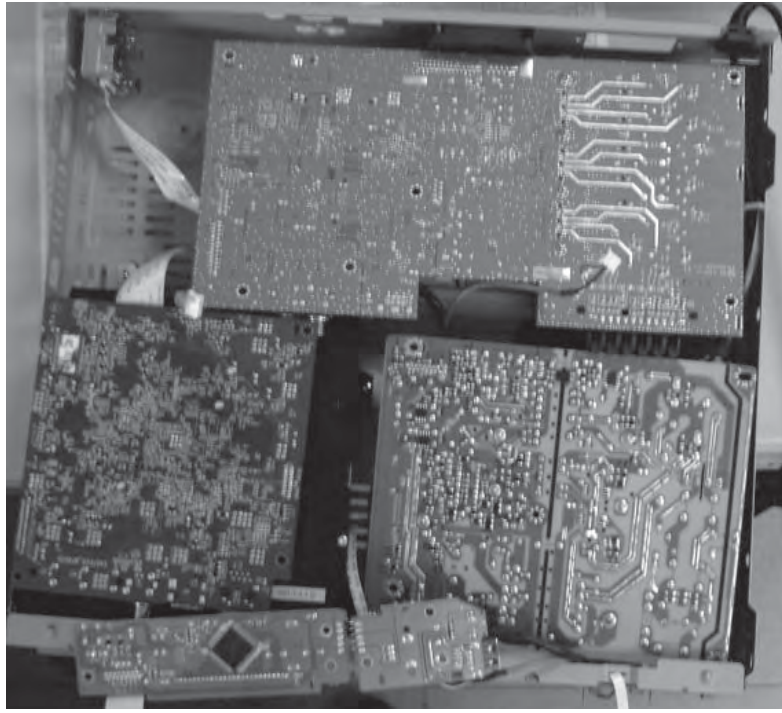
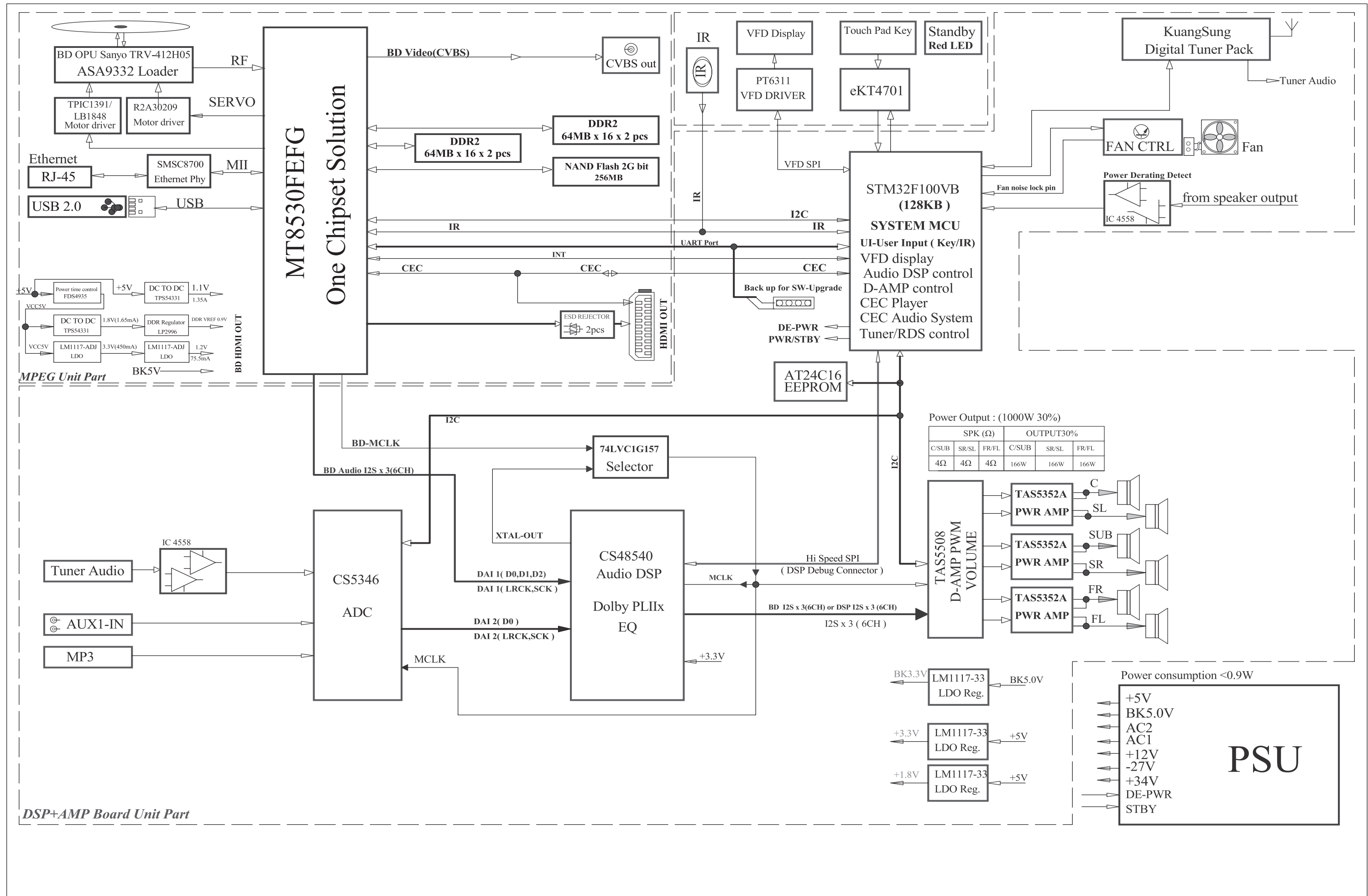
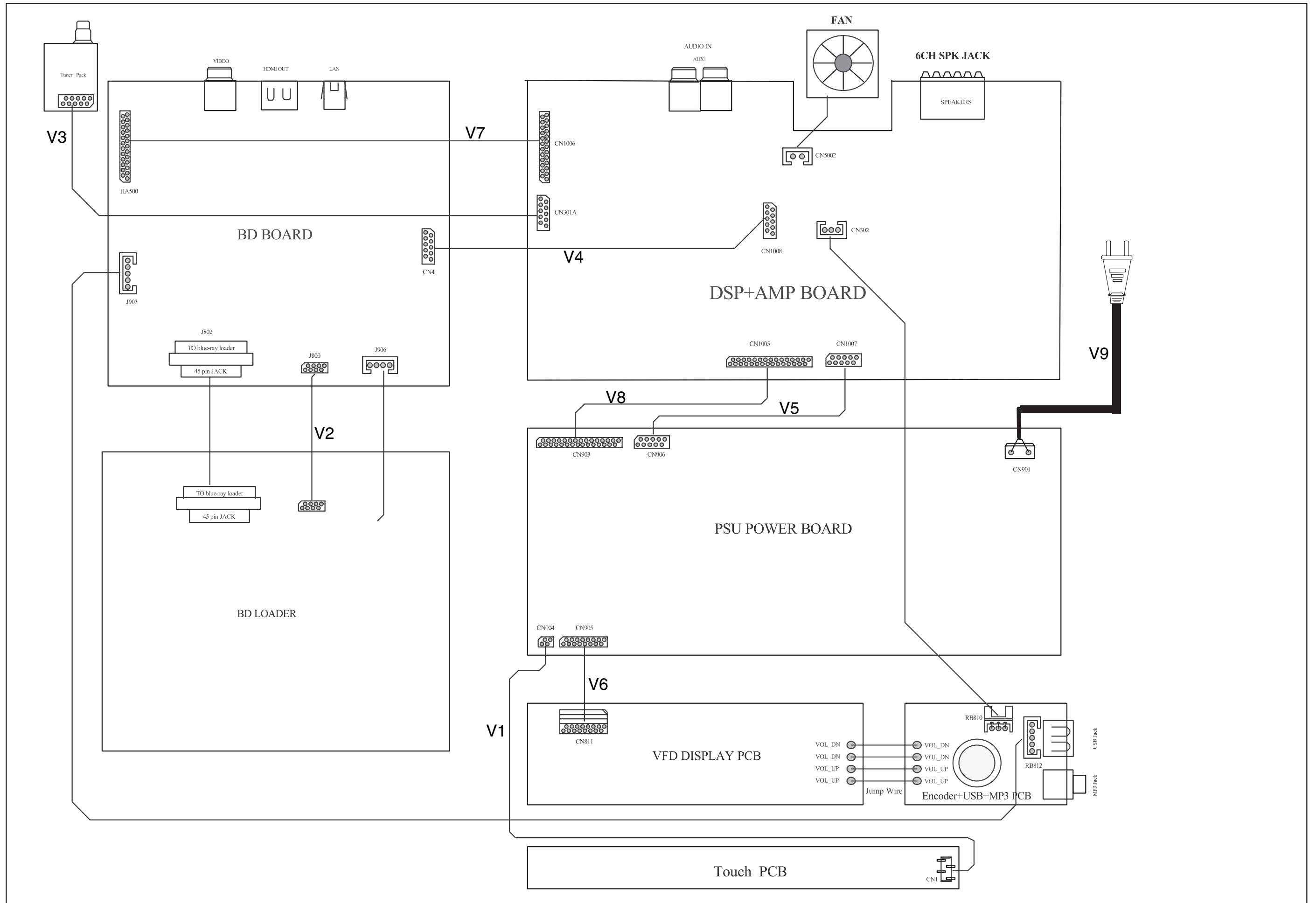

Figure 16



Note: In some service positions the components or copper patterns of one board may risk touching its neighbouring pc boards or metallic parts. To prevent such short-circuit use a piece of hard paper or other insulating material between them.





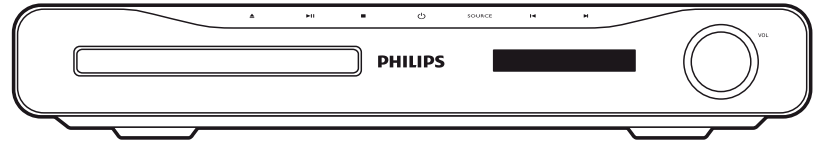
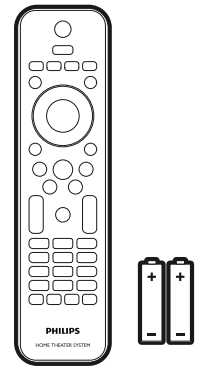

FM Antenna

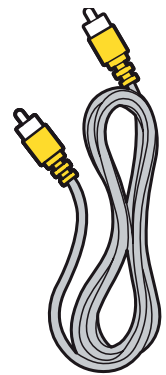

Audio/Video

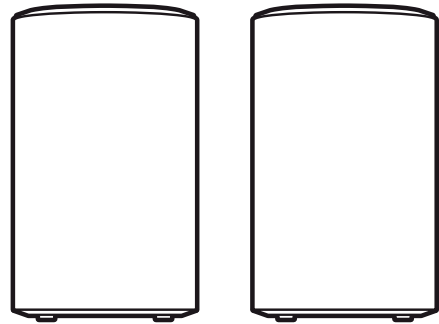
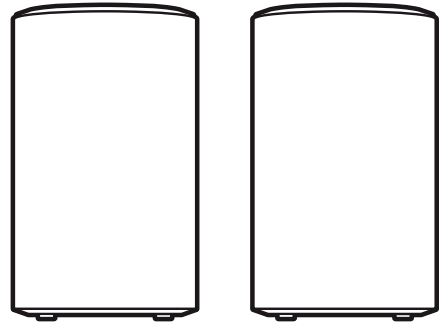
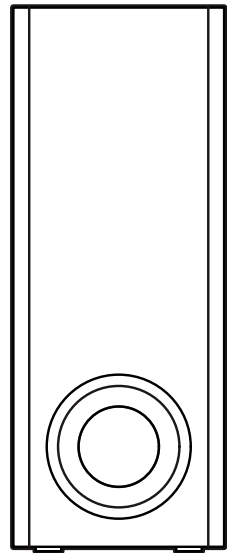

1

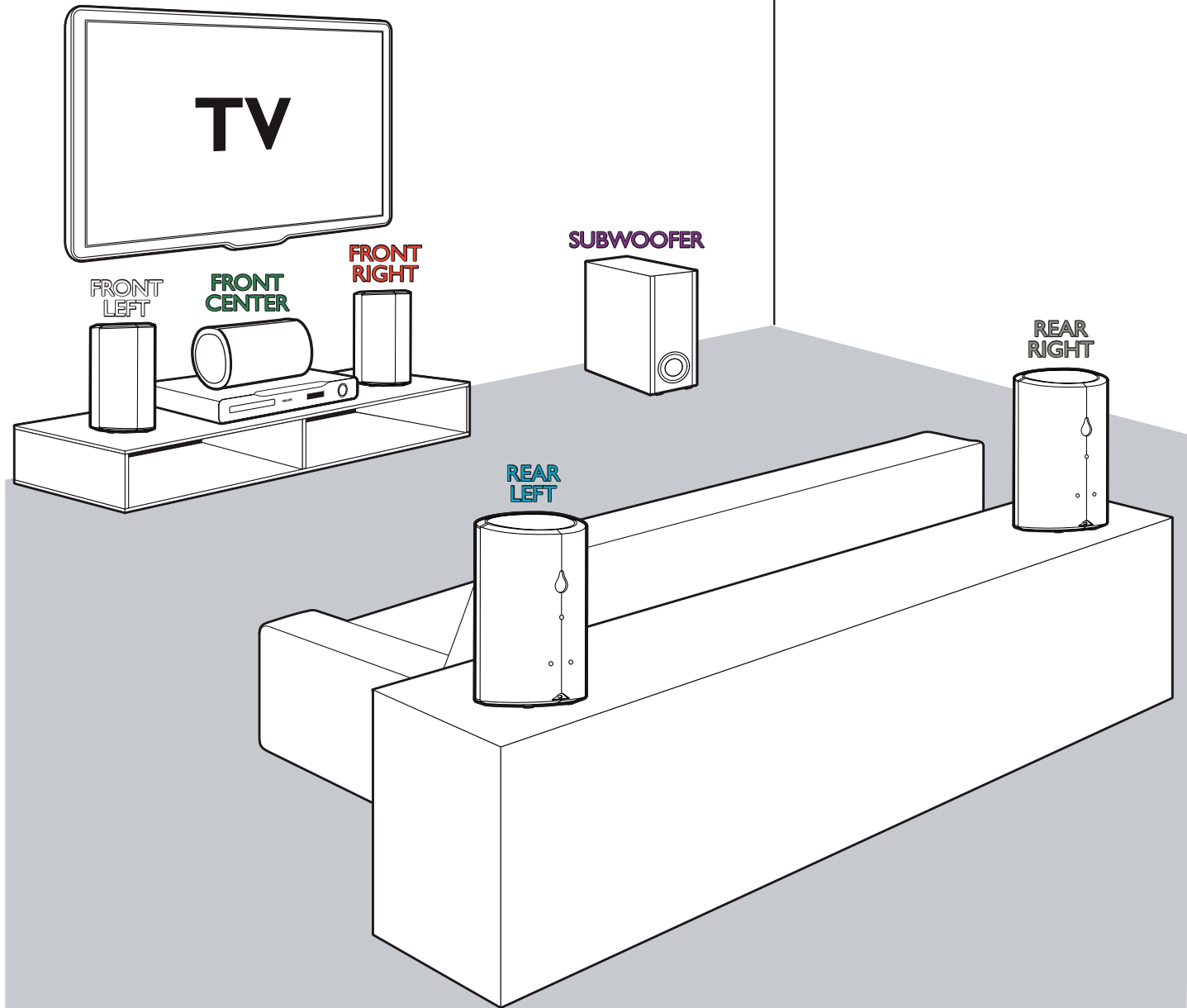

2

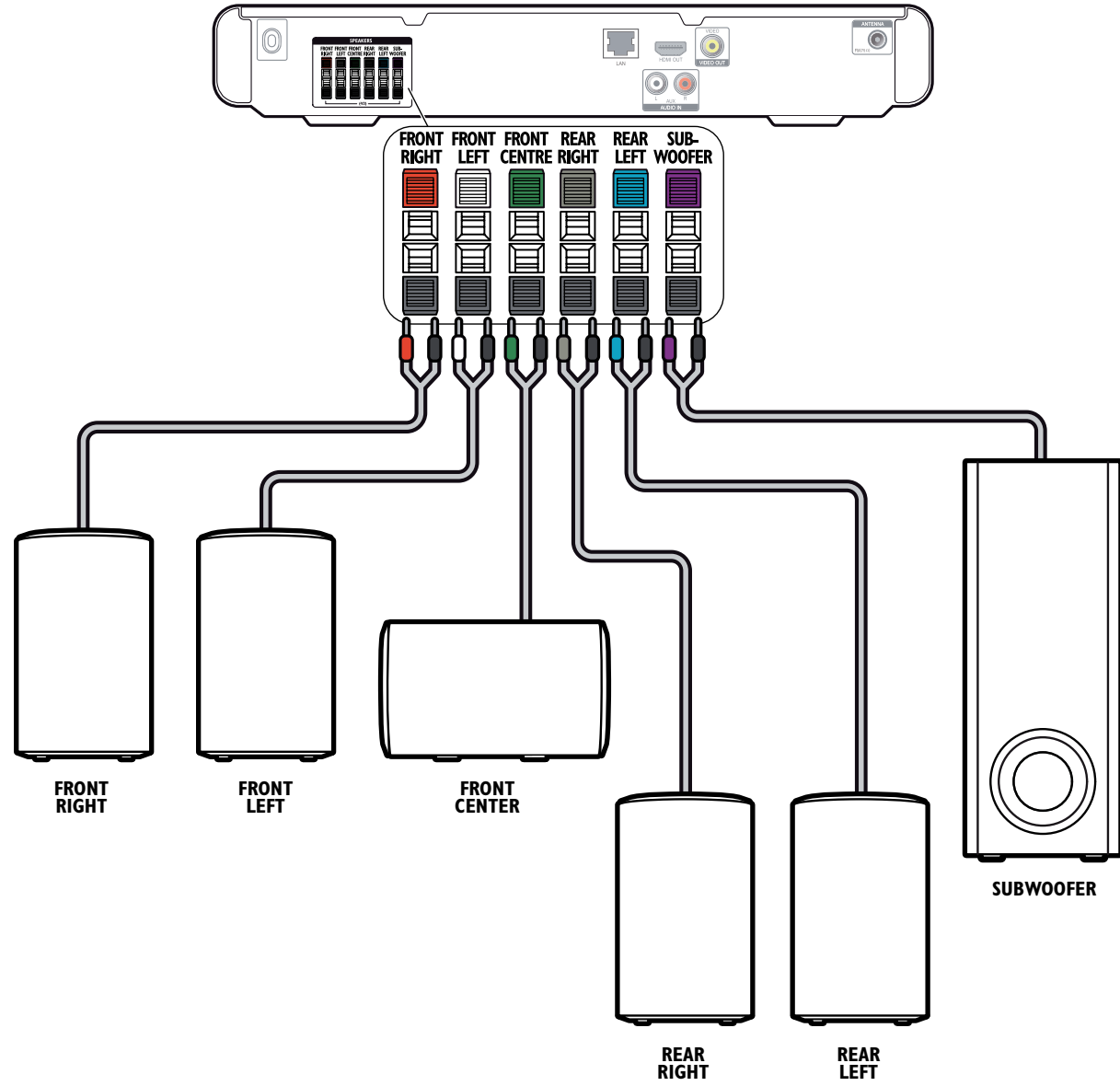

4

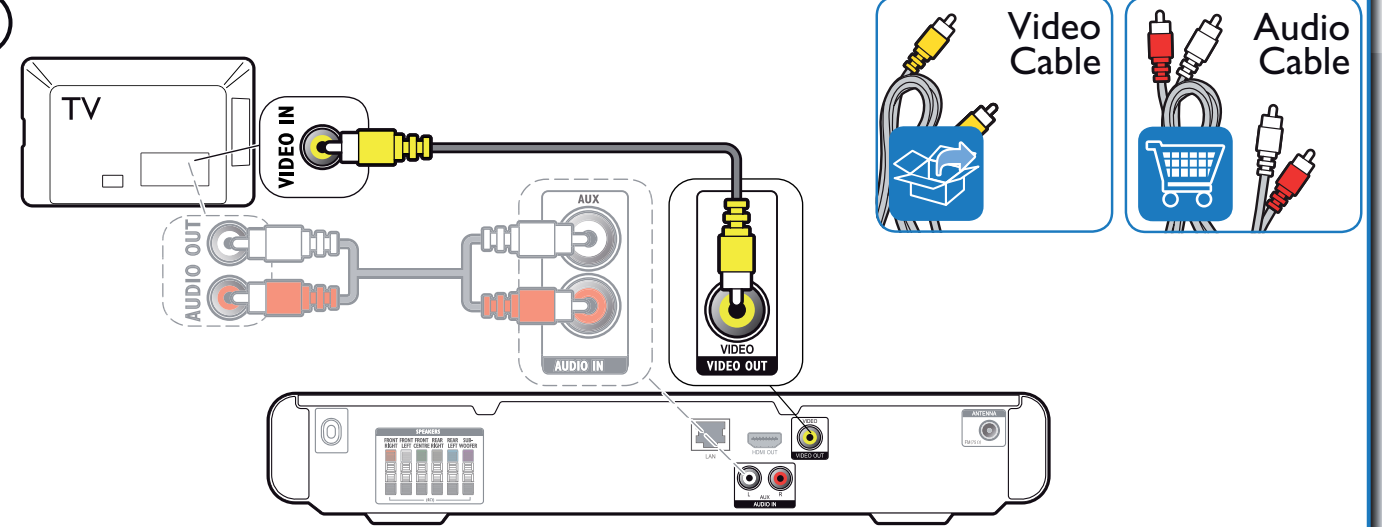

5

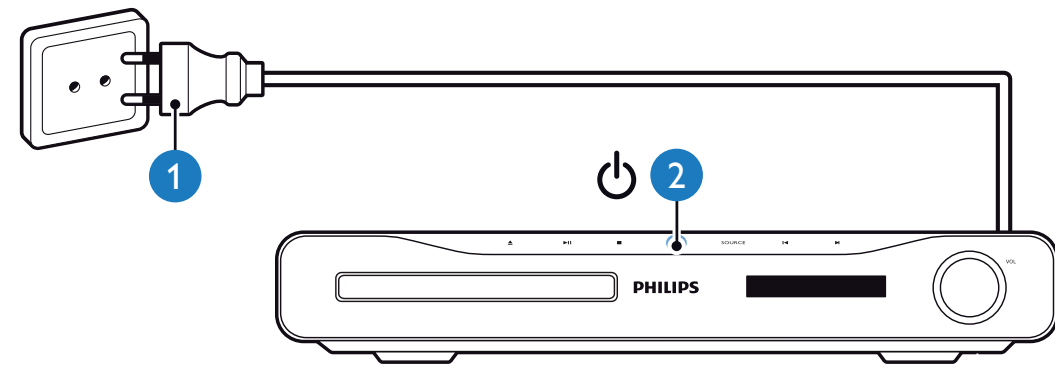

3

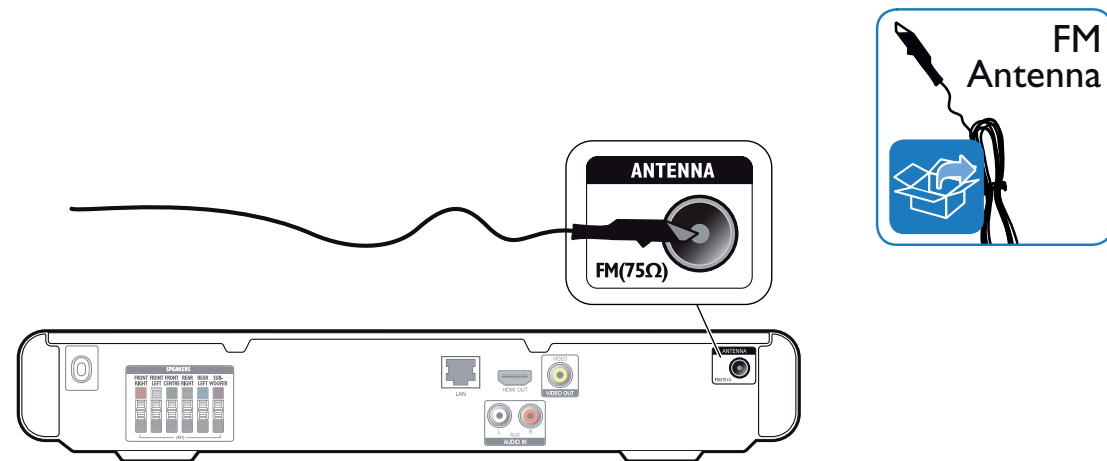

6

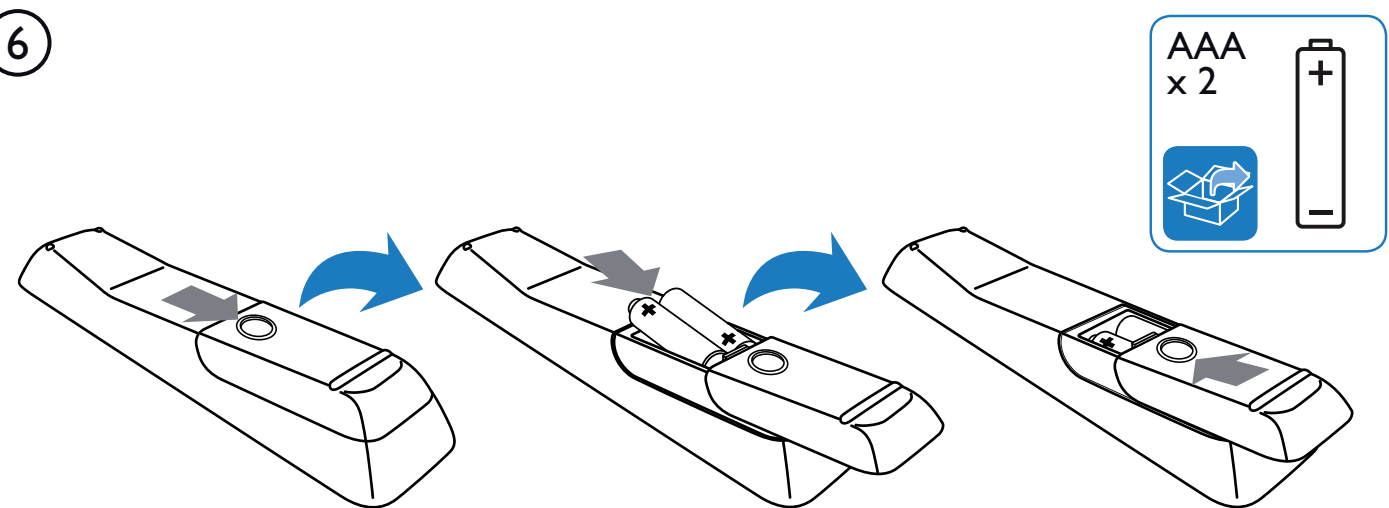

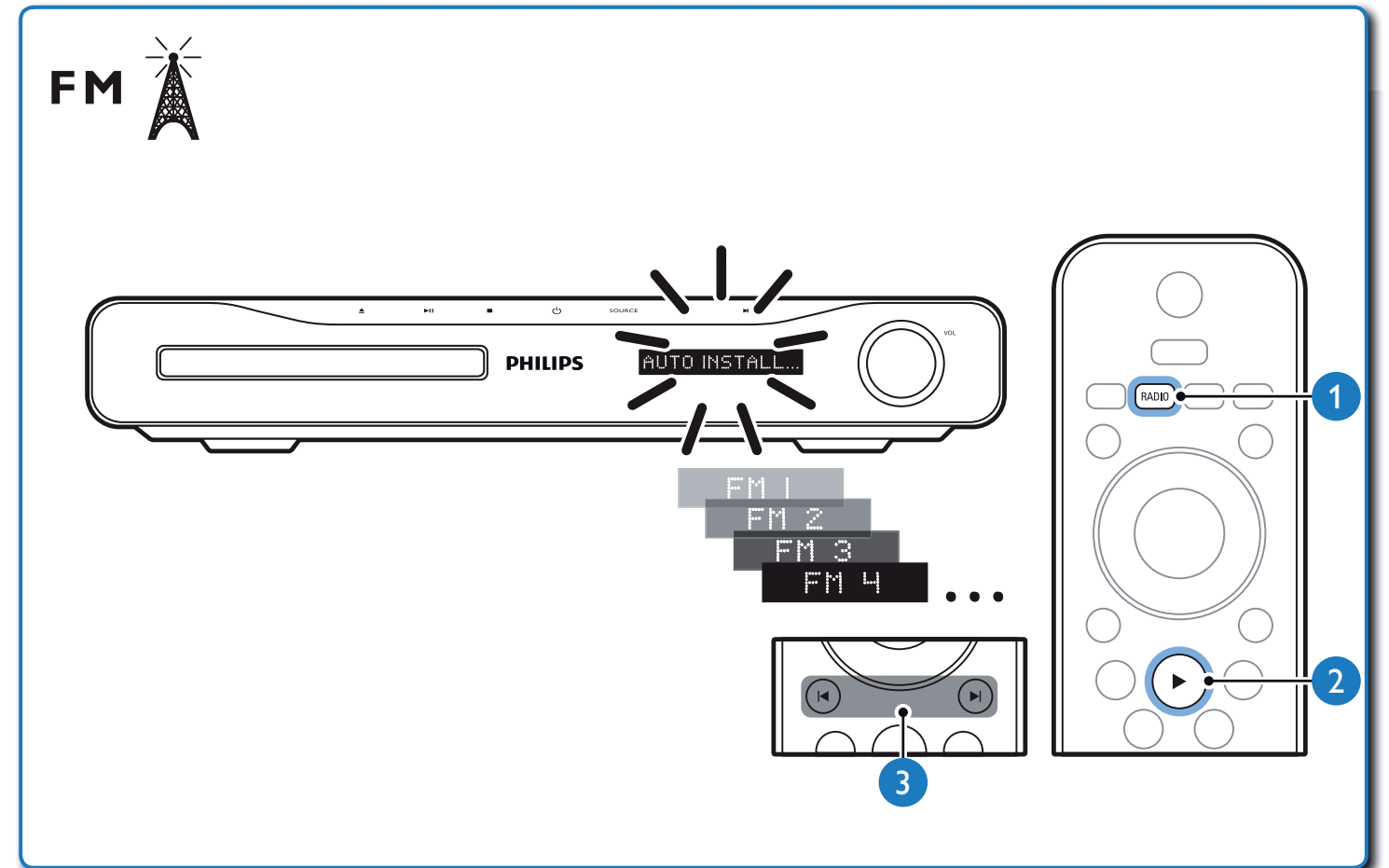
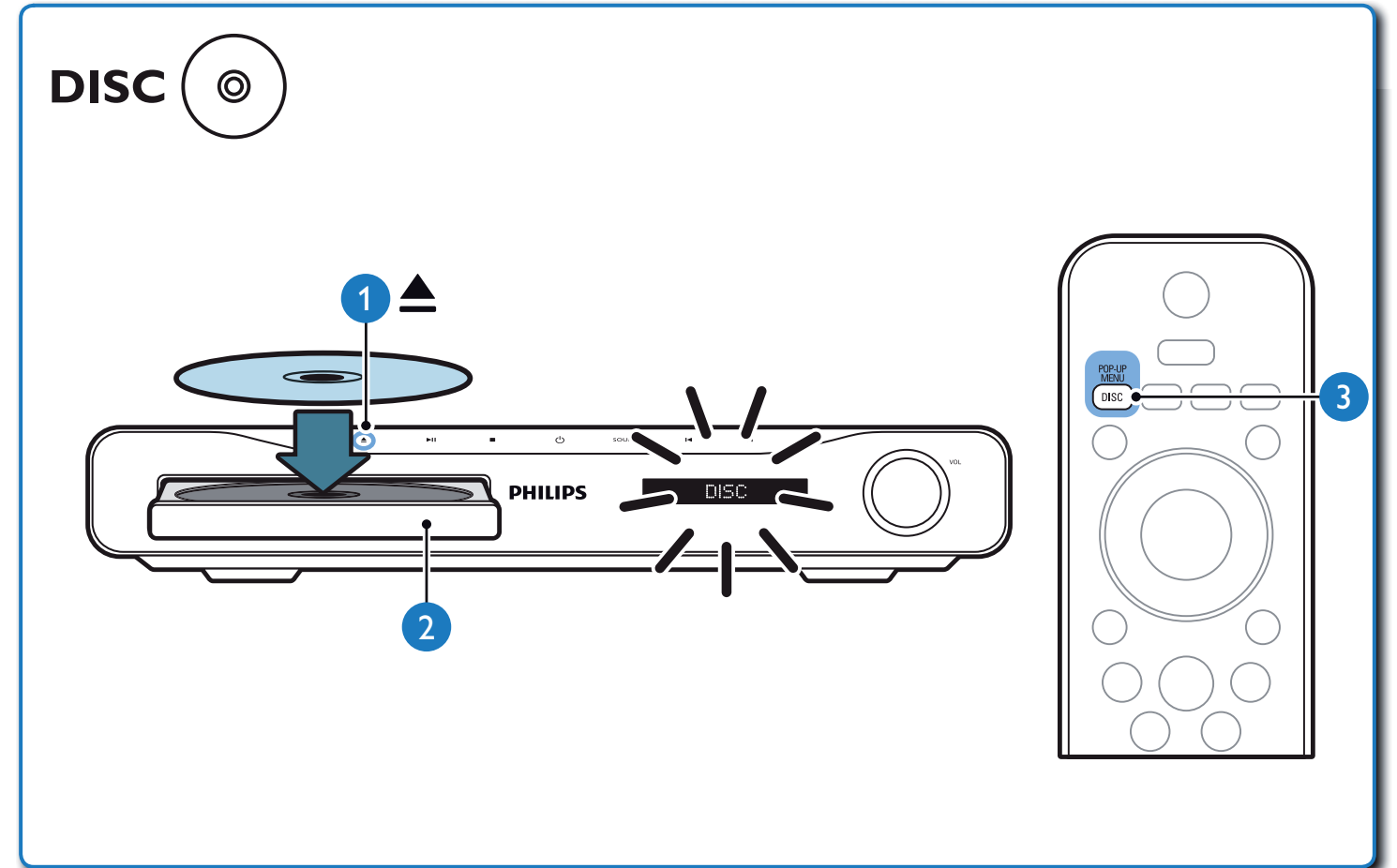
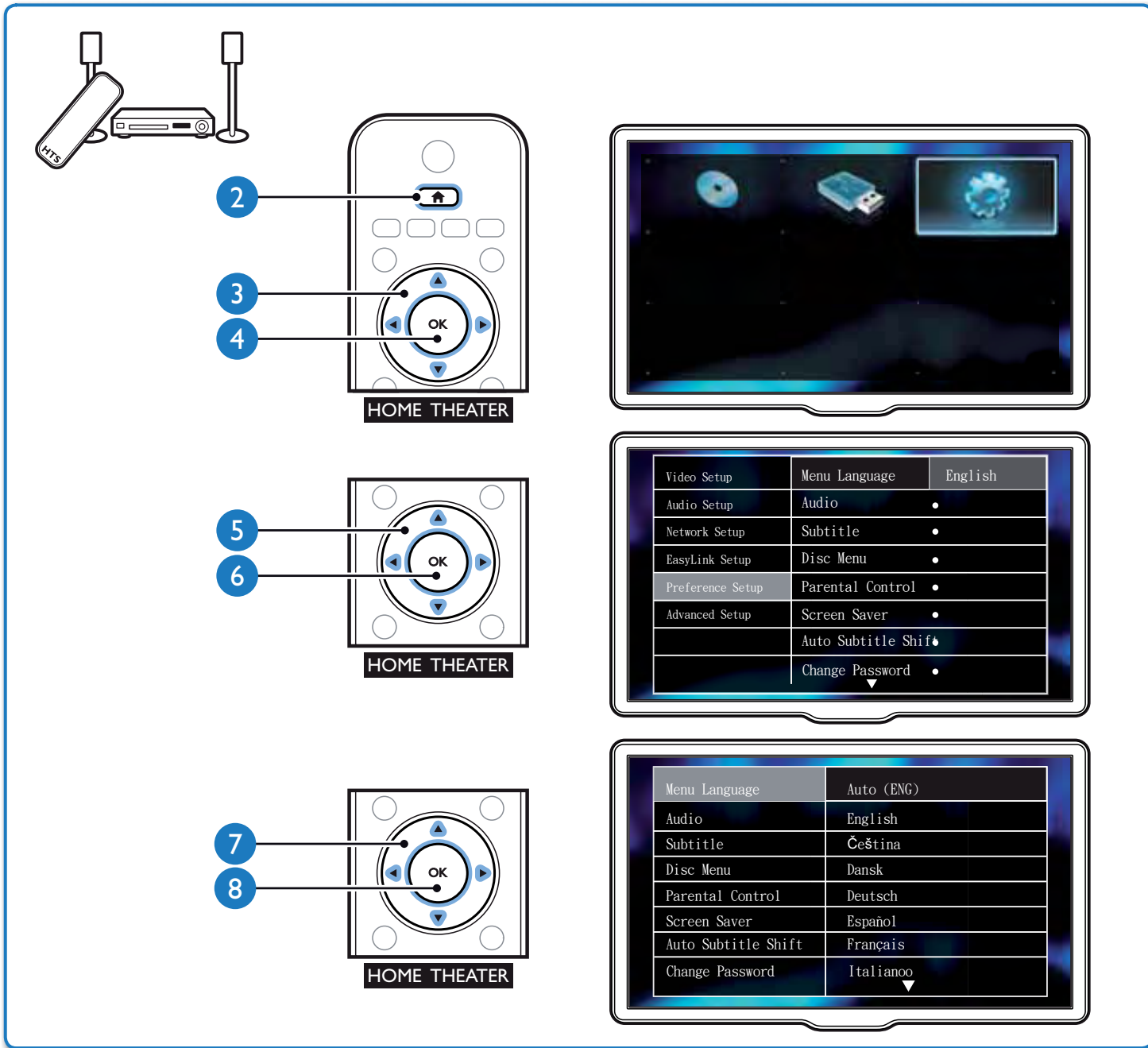
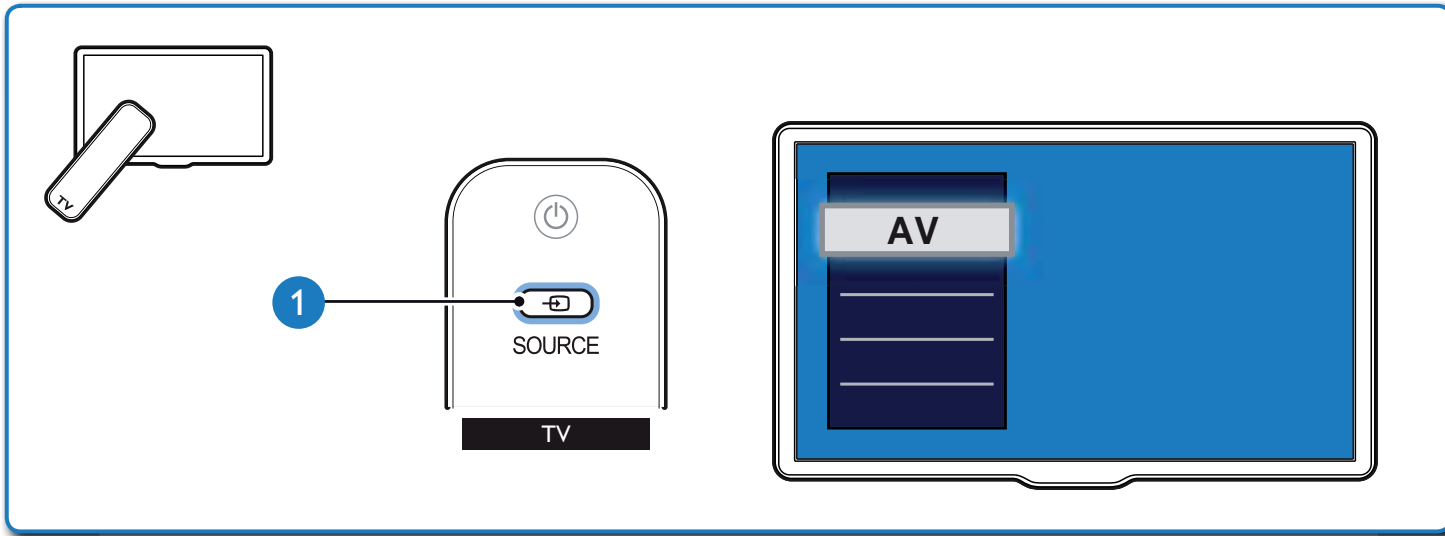

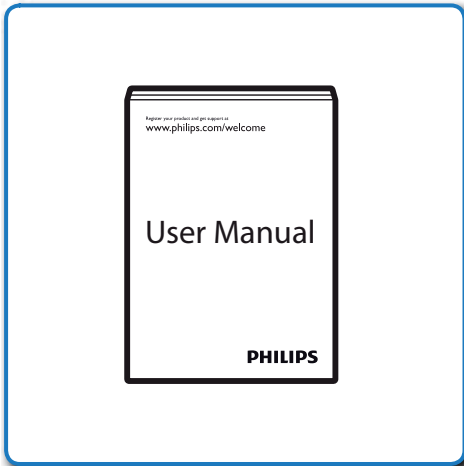
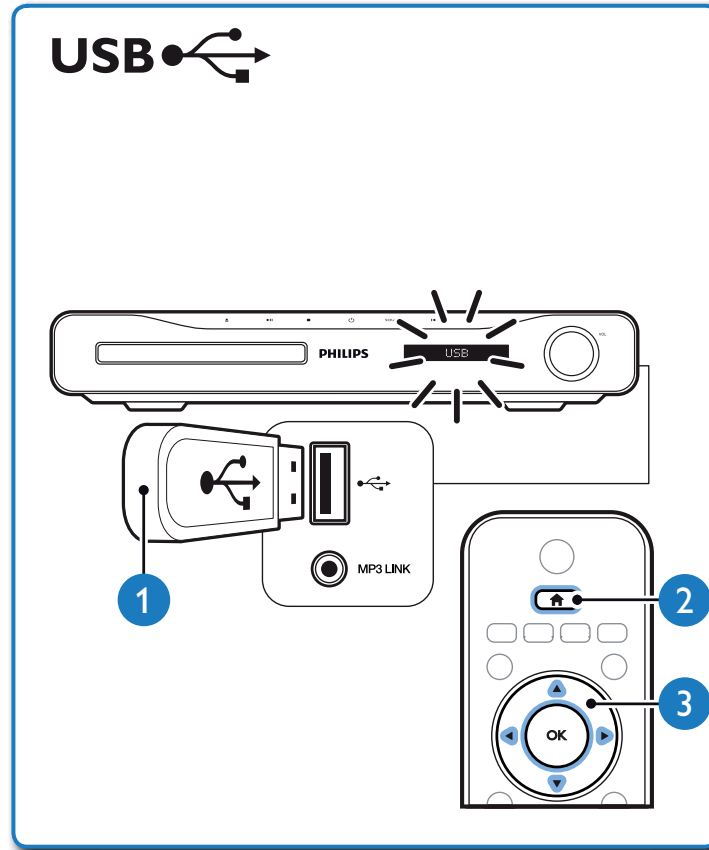
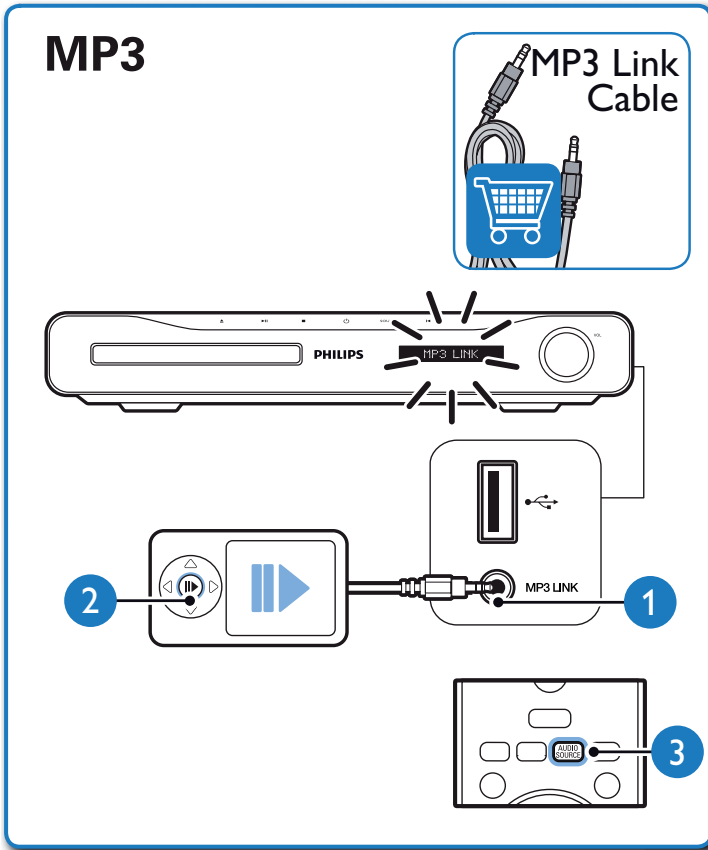

Specifications are subject to change without notice
 Trademarks are the property of Koninklijke Philips Electronics N.V.
 or their respective owners
 2010 © Koninklijke Philips Electronics N.V. All rights reserved.
 sgsna_1015/12_v2

Be responsible
 Respect copyrights



FTD DISPLAY PIN ASSIGNMENT

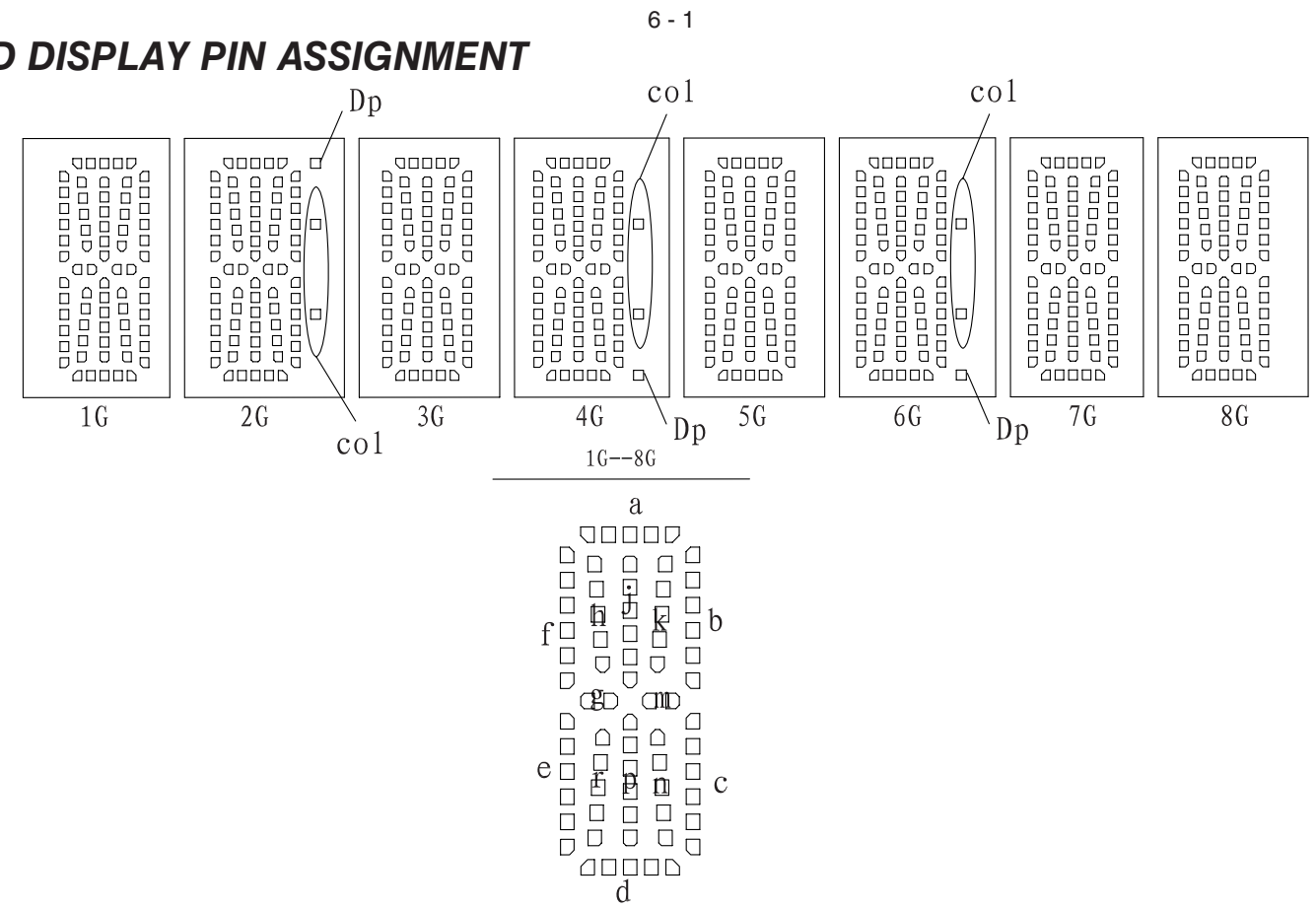

VFD+VOL+USB+MP3 BOARD

TABLE OF CONTENTS

FTD Display Pin Assignment.....6-1
 Circuit Diagram6-2
 PCB Layout Top & Bottom View.....6-3

	1G	2G	3G	4G	5G	6G	7G	8G
P1	a	a	a	a	a	a	a	a
P2	j, p	j, p	j, p	j, p	j, p	j, p	j, p	j, p
P3	h	h	h	h	h	h	h	h
P4	k	k	k	k	k	k	k	k
P5	b	b	b	b	b	b	b	b
P6	f	f	f	f	f	f	f	f
P7	m	m	m	m	m	m	m	m
P8	g	g	g	g	g	g	g	g
P9	c	c	c	c	c	c	c	c
P10	e	e	e	e	e	e	e	e
P11	r	r	r	r	r	r	r	r
P12	n	n	n	n	n	n	n	n
P13	d	d	d	d	d	d	d	d
P14	/	col	/	col	/	col	/	/
P15	/	Dp	/	Dp	/	Dp	/	/

PIN CONNECTION

(Pin NO.)	1	2	3	4	5	6	7	8	9	10	11	12	13	14	15	16
(Connection)	F1	F1	NP	NC	P15	P14	NC	P13	P12	P11	P10	P9	P8	P7	P6	P5
(Pin NO.)	17	18	19	20	21	22	23	24	25	26	27	28	29	30	31	32
(Connection)	P4	P3	P2	P1	NC	1G	2G	3G	4G	5G	6G	7G	8G	NP	F2	F2

(Notes) : Fn : (Filament Pin) nG : (Grid Pin)
 Pn : (Anode Pin) NP : (No Pin)
 NC : (No connection Pin)

CIRCUIT DIAGRAM

C810	A1	C813	B2	C816	B2	C819	A3	C822	B2	CN810	B1	DP810	A2	IC810	B2	R811	B1	R814	B1	R817	A2	R820	B1	R823	B2	VR810	C1	ZD811	B2		
C811	B1	C814	B1	C817	B2	C820	B2	C823	C1	CN811	A1	FB810	B1	IC810	B2	R812	B1	R815	B2	R818	A3	R821	B2	SN810	B1	VR810	C1				
C812	B1	C815	B2	C818	A3	C821	B2	C824	C1	CN812	B1	FB812	B1	JK810	B1	R813	B1	R816	B2	R819	B1	R822	B2	USB810B1		ZD810	B1				

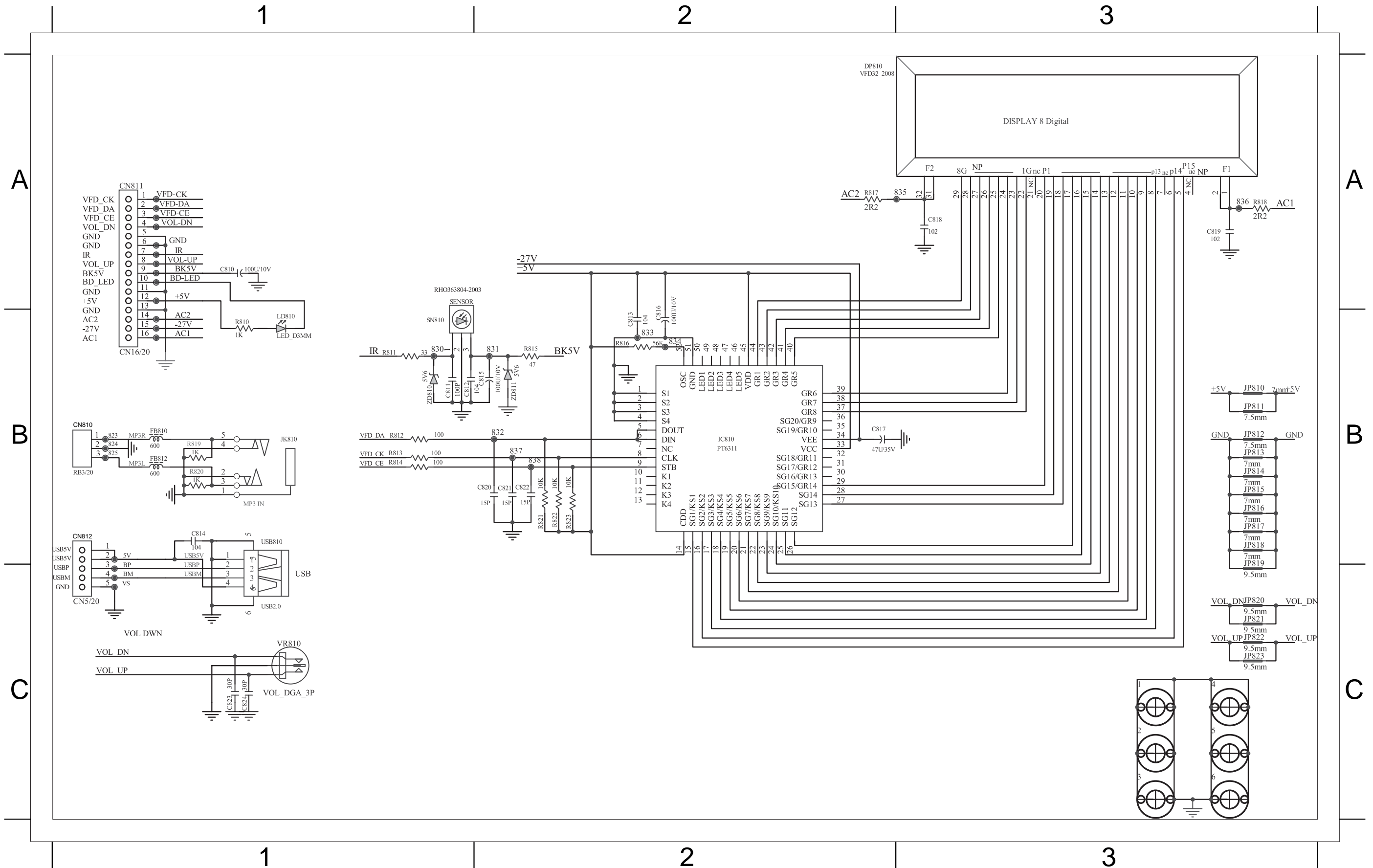

PCB LAYOUT - TOP VIEW

C810	A1	C817	A1	CN812	A3	JP810	A1	JP813	A2	JP816	A3	JP819	A2	JP822	A2	USB810	A3
C815	A1	CN810	A3	DP810	A1	JP811	A1	JP814	A2	JP817	A1	JP820	A2	JP823	A2	VR810	A3
C816	A1	CN811	A1	JK810	A3	JP812	A1	JP815	A1	JP818	A1	JP821	A2	SN810	A1		

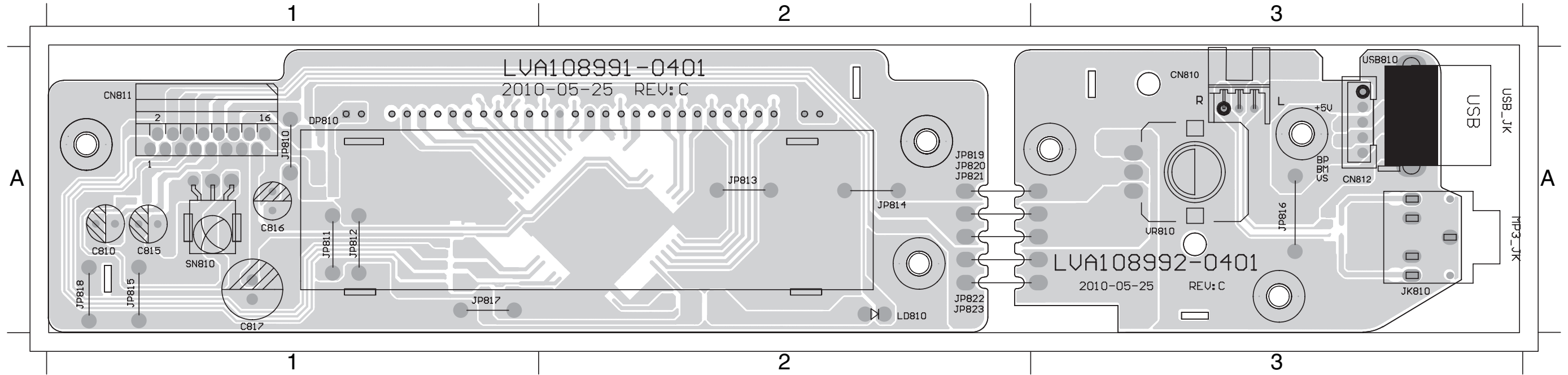

PCB LAYOUT - BOTTOM VIEW

C811	A1	C814	A3	C820	A1	C823	A3	FB812	A3	R812	A1	R815	A1	R818	A1	R821	A1	R824	A1	ZD811	A1
C812	A1	C818	A1	C821	A2	C824	A3	IC810	A2	R813	A1	R816	A2	R819	A3	R822	A1	R825	A1		
C813	A1	C819	A1	C822	A1	FB810	A3	R811	A1	R814	A1	R817	A1	R820	A3	R823	A1	ZD810	A1		

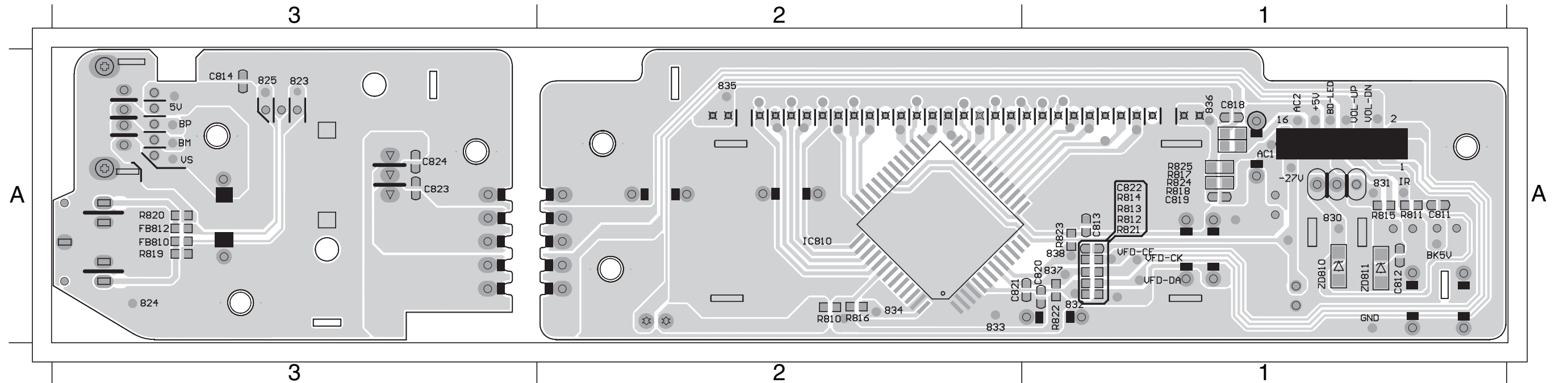

MAIN BOARD

TABLE OF CONTENTS

Internal IC Diagram 7-1
 Circuit Diagram 7-2
 PCB Layout Top View 7-3
 PCB Layout Bottom View 7-4

INTERNAL IC DIAGRAM - STM32F100VBT6ATR

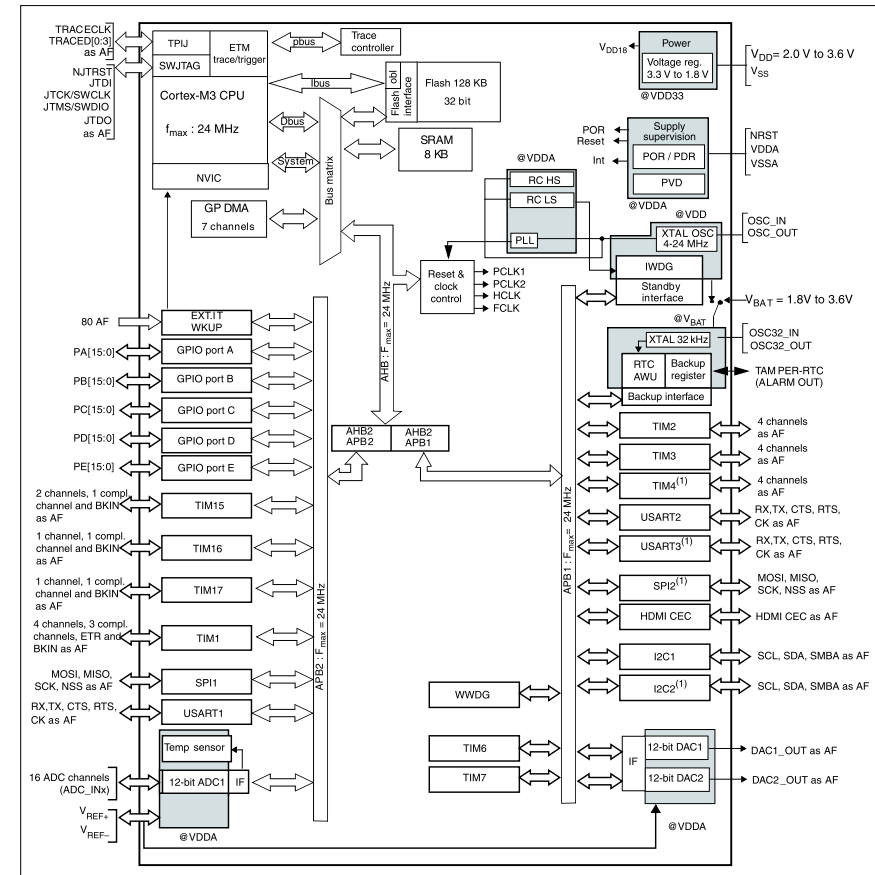

INTERNAL IC DIAGRAM - CS5346-CQZR

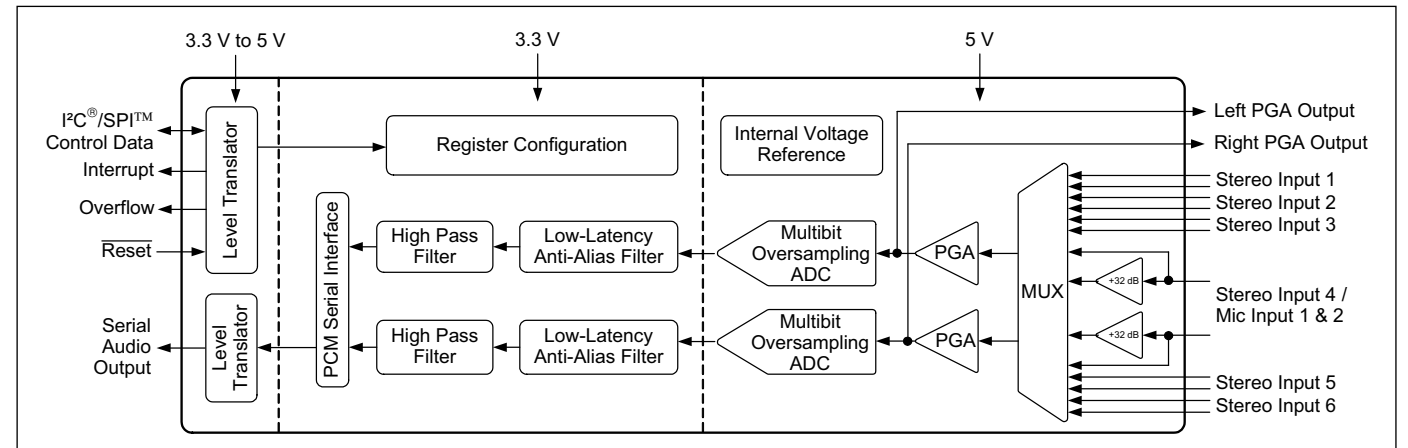

CIRCUIT DIAGRAM

7-2

7-2

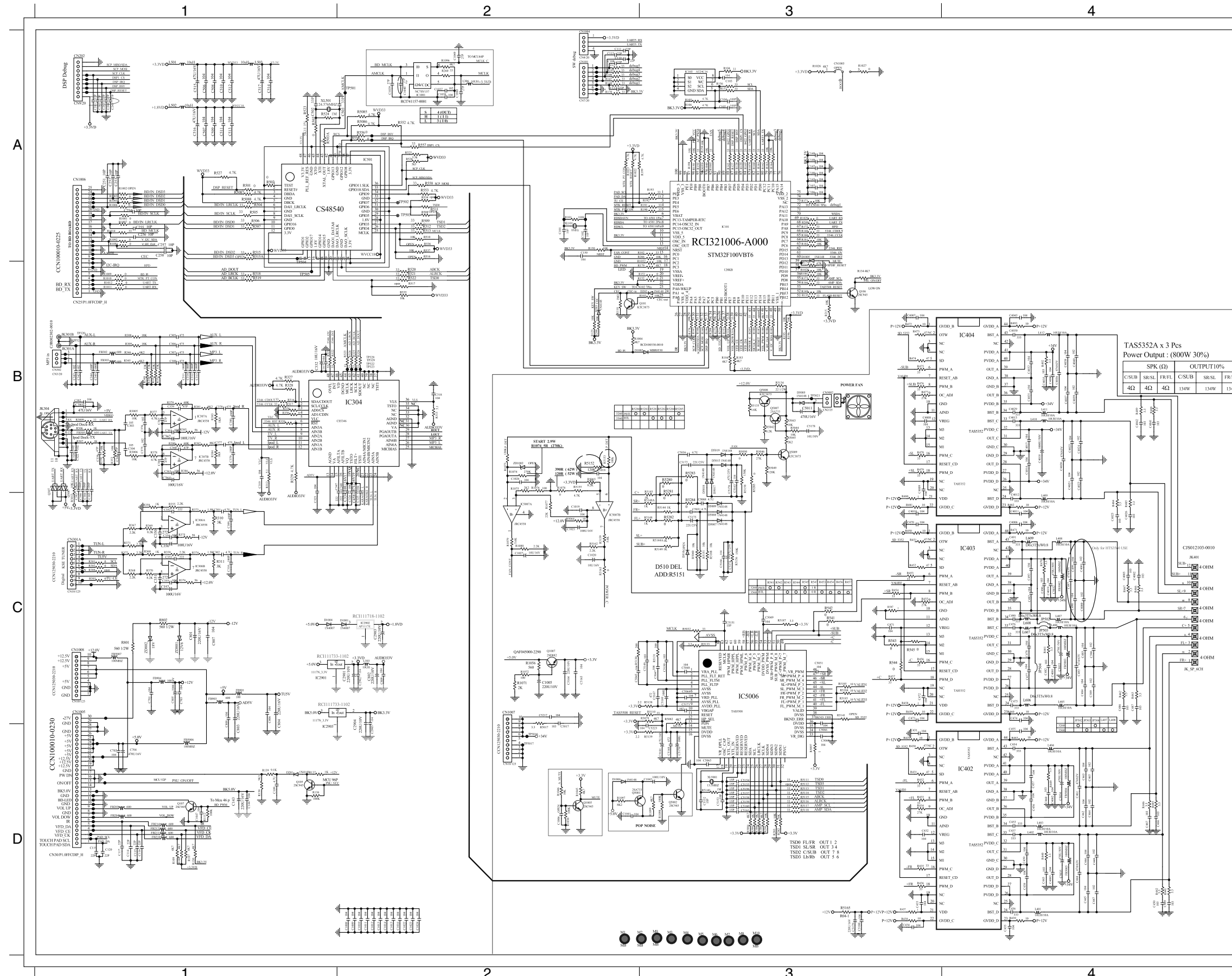

C1005	C2	C350	C1	C497	C4	D5005	B3	R1056	C2	R284	D3	R503	A1
C1008	D2	C351	C1	C498	C4	D5007	C3	R106	A3	R301	C1	R5032	C3
C1009	D2	C352	C1	C499	C4	D5008	C3	R1065	D3	R302	C1	R503A	A1
C101	A2	C353	C1	C5011	B3	D5015	B3	R1066	D3	R303	C1	R504	A1
C1010	D2	C354	C1	C5017	C2	D5017	B3	R1067	B3	R308	B1	R5040	C3
C1011	D2	C355	C1	C502	A1	D5018	B3	R107	D1	R309	B1	R5042	B3
C1012	D2	C356	C1	C503	A2	D5019	B3	R1070	A3	R310	C1	R5043	B3
C1013	D2	C357	C1	C5031	C3	FB203	D1	R1071	C2	R311	C1	R5044	B3
C1014	D2	C4000	C4	C5032	C4	FB204	D1	R1072	C2	R312	B1	R5045	B3
C1015	D2	C4001	C4	C5033	C4	FB210	D1	R1073	B2	R313	B2	R5046	B3
C1016	D2	C4002	C4	C5034	D4	FB211	D1	R1074	B2	R316	B1	R5049	B3
C1018	B2	C4003	C4	C5035	D4	FB212	D1	R1075	B2	R317	B1	R505	A1
C1019	C2	C4006	C4	C5036	B3	FB214	D1	R1076	B2	R318	B3	R5050	B3
C102	A2	C4007	B3	C5045	C2	FB302	B1	R1077	A2	R319	B3	R506	A1
C1020	C2	C4008	B3	C5047	C3	FB303	B1	R1078	B2	R320	B1	R5064	C2
C1021	C2	C4009	B3	C5048	C3	FB5002	C4	R1079	C2	R321	B1	R5065	B2
C1022	D2	C4010	C3	C5049	C3	FB5003	C4	R108	D1	R322	B1	R507	A1
C1023	D2	C4011	C4	C5051	C3	FB5004	D4	R1080	C2	R323	B2	R5079	C3
C1024	D2	C4012	C4	C506	A1	FB5005	D4	R109	D1	R324	B2	R5082	C3
C1026	B2	C4013	B4	C5064	C3	FB5006	D1	R1091	A1	R325	B2	R5083	D3
C1027	C2	C4014	B4	C5065	D3	FB5007	C1	R1092	A1	R326	B2	R5084	D3
C103	A3	C4015	B4	C5066	D3	FB901	C1	R1093	A1	R327	B1	R5085	A2
C1037	A2	C4018	B4	C5067	D3	FB903	C1	R1096	A2	R328	B1	R5086	A2
C1038	A2	C4019	C4	C507	A1	FB904	C1	R1097	D2	R329	B1	R5087	A1
C1039	A2	C4020	B4	C508	A1	IC1001	A2	R1098	D3	R345	B1	R5088	A1
C104	A3	C4021	B4	C509	A1	IC101	A3	R1099	D3	R346	B1	R509	A2
C1040	A2	C4022	B4	C510	A1	IC103	A3	R110	B2	R348	B1	R5097	D3
C1041	D2	C4023	B4	C511	A1	IC2901	C1	R1112	D1	R349	B1	R510	A2
C1042	D3	C4024	B4	C512	A1	IC2902	C2	R125	B2	R351	B1	R5110	C3
C1047	D1	C4025	C4	C513	A1	IC2903	C1	R127	A3	R352	B1	R5111	D3
C1048	A2	C4026	C4	C514	A1	IC304	B2	R128	A3	R354	B1	R5113	D3
C1049	A2	C4029	B4	C5149	C3	IC306	C1	R129	A3	R355	C1	R5114	D3
C105	A3	C4030	B4	C515	A1	IC402	D4	R130	D1	R356	B1	R5115	D3
C106	A3	C4031	B4	C5150	C3	IC403	C4	R134	B3	R358	C1	R5116	D3
C107	A3	C4032	B4	C5151	C3	IC404	B4	R135	B3	R359	C1	R5117	D3
C108	A2	C4035	B4	C5152	D3	IC5006	C3	R136	D1	R360	C1	R5118	D3
C109	D1	C4036	B4	C5153	D3	IC5007	C2	R137	D1	R367	C1	R512	A2
C110	A2	C4037	B4	C5154	D3	IC501	A2	R138	D1	R368	C1	R513	A2
C111	A2	C4038	B4	C5155	D3	JK301	B1	R139	D1	R369	C1	R5130	C2
C112	A2	C4039	B4	C5156	D3	JK401	C4	R140	A3	R370	C1	R5131	C3
C113	A2	C4040	B4	C5157	D3	L303	C2	R144	A2	R371	C1	R5133	C3
C114	D1	C4041	B4	C5158	D3	L306	A2	R145	A2	R372	C1	R5134	B3
C115	D1	C4042	B4	C5159	D3	L401	D4	R146	A2	R373	C1	R5135	B3
C116	D1	C4045	B4	C516	A1	L402	D4	R147	A2	R374	C1	R5138	C3
C117	D1	C4080	B4	C5160	D3	L403	D4	R148	A2	R375	C1	R5139	D3
C119	D1	C4081	C4	C5161	D3	L404	D4	R149	B3	R376	C1	R5140	D3
C120	D1	C4082	D4	C5163	B3	L405	C4	R150	A2	R429	D3	R5144	C3
C143	D1	C4083	D4	C5164	C2	L406	C4	R151	B3	R431	D3	R5144A	C3
C144	D1	C431	D3	C5165	C2	L407	C4	R152	B3	R432	D3	R5145	C3
C145	A3	C432	D3	C5166	C3	L408	C4	R153	B3	R433	D3	R5148	C3
C146	A3	C433	D3	C5167	C3	L409	C4	R154	A3	R434	D3	R5148A	C3
C147	A3	C434	D3	C5168	D3	L410	B4	R156	A3	R435	D3	R5149	C3
C148	A3	C435	D4	C5169	C3	L411	B4	R157	A3	R436	D3	R515	A1
C149	A3	C436	D4	C517	A1	L412	B4	R158	A3	R437	D3	R5151	C3
C150	A2	C437	D4	C5170	D3	L501	A1	R159	A3	R438	D3	R5152	B2
C241	A1	C438	D4	C5171	C3	L502	A1	R160	A3	R439	D4	R5153	B2
C242	A1	C439	D4	C5172	B3	L503	A1	R161	A3	R440	D4	R5155	B2
C243	A1	C443	D4	C5174	C3	L606	C4	R162	A3	R441	D4	R5156	C3
C244	A1	C444	D4	C5175	C3	L607	C4	R163	A3	R442	D4	R5158	B3
C245	A1	C445	D4	C5176	B3	Q1005	D2	R164	A3	R445	D4	R5159	C2
C251	A1	C446	D4	C5178	B3	Q1005	D2	R165	A3	R446	D4	R5162	C2
C252	A1	C447	D4	C5179	D3	Q1007	C2	R166	B3	R449	D4	R5163	C2
C253	A1	C448	D4	C5180	D3	Q101	B2	R167	B3	R450	C3	R5165	D3
C254	A1	C449	D4	C5181	D3	Q105	D1	R168	B3	R452	C3	R518	A1
C255	A1	C450	D4	C5217	C2	Q106	B3	R169	B3	R453	C3	R5183	C3
C256	A1	C453	D4	C5223	D3	Q107	B1	R170	A2	R454	C3	R5184	C3
C257	A1	C454	D4	C589	C4	Q5001	D2	R171	A3	R455	C3	R5185	C3
C258	A1	C455	D4	C590	C4	Q5002	D3	R172	A3	R456	C3	R5187	C3
C2901	C2	C456	D4	C701	C1	Q5007	B3	R173	B3	R457	C3	R519	A1
C2902	C2	C457	D4	C702	D1	Q5008	B3	R174	A3	R458	C3	R520	B2
C2903	C2	C458	C2	C703	C1	Q5009	B3	R175	B3	R459	C3	R521	B2
C2904	C2	C460	D4	C704	D1	R1001	A1	R178	B3	R460	C4	R522	B2
C2905	C2	C461	D4	C801	C1	R1002	A1	R179	B3	R461	C4	R523	A1
C301	C1	C462	D4	C802	C2	R1004	B2	R180	A3	R462	C4	R524	A1
C302	C1	C463	D4	C803	C1	R1005	A1	R181	A3	R463	C4	R525	A2
C305	B1	C464	D4	C804	C1	R1006	A1	R182	A3	R466	C4	R526	A2
C306	B1	C465	D4	C805	C1	R1007	A1	R183	B3	R467	C4	R527	A1
C307	B1	C466	D4	C806	C1	R1009	B1	R184	B3	R470	C4	R5281	B3
C308	B1	C467	D4	C807	C1	R101	A2	R185	B3	R471	C4	R5282	C3
C309	C1	C470	C3	C808	C1	R1010	B1	R186	B3	R472	B3	R5284	C3
C310	C1	C471	C3	C809	C2	R1011	B1	R189	B3	R474	B3	R535	B2
C311	B1	C472	C3	CN1004	A2	R1012	B1	R190	A3	R475	B3	R537	A2
C312	B1	C473	C3	CN1005	C1	R1014	A1	R191	A3	R476	B3	R543	C3
C313	B1	C474	C4	CN1006	A1	R102	A3	R192	A3	R477	B3	R547	C3
C314	B1	C475	C4	CN1007	C2	R1022	A2	R193	A3	R478	B3	R552	A2
C317	B1	C476	C4	CN1008	C1	R1023	A2	R194	B3	R479	B3	R553	A2
C318	B2	C477	C4	CN101	A2	R1026	A3	R195	B3	R480	C3	R554	A2
C319	B1	C478	C4	CN202	A1	R1027	A3	R196	B3	R481	C3	R556	A2
C323	C1	C482	C4	CN301A	C1	R1028	B3	R198	A3	R482	C4	R557	A2
C324	C2	C483	C4	CN302	B1	R1029	A3	R199	A2	R483	D4	R558	A2
C325	C2	C484	C4	CN5002	B3	R103	B3	R200	B2	R484	C4	R801	C1
C332	B1	C485	C4	D1001	C2	R1038	D2	R206	A3	R485	C4	R802	C1
C334	C2	C486	C4	D1002	B2	R104	A3	R207	B3	R488	B4	XL101	A2
C342	B1	C487	C4	D1004	C1	R1040	A3	R208	B3	R489	B4	XL5001	D3
C343	B1	C490	C4	D1005	A3	R1041	A3	R209	A3	R492	B4	XL501	A1
C344	B1	C491	C4	D1006	D2	R1045	D2	R215	B3	R493	B4	ZD801	C1
C345	B1	C492	C4	D201	D1	R1046	D2	R260	A2	R501	A1	ZD802	C1
C347	B2	C493	C4	D202	B3	R1045	A3	R282	D3	R5017	C2		
C348	B2	C496	C4	D203	B2	R1052	A3	R283	D3	R502	A1		

PCB LAYOUT - TOP VIEW

C1005	C3	C116	C2	C301	B1	C347	B1	C4019	B3	C439	C3	C483	A4	C5067	C3	C5178	A2	CN1008B2	FB203	C2	IC2902	C2	L407	B4	Q5002	C3	R1029	B1	R1077	B3	R135	B1	R168	C1	R198	C1	R321	B1	R370	B1	R453	B3	R483	C3	R507	C2	R5134	A2	R521	C2	
C101	C1	C117	C2	C302	B1	C348	B1	C4020	A4	C443	C3	C490	B3	C509	C2	C5179	C3	CN101	B1	FB204	C2	IC2903	C1	L408	B4	Q5007	A3	R103	C1	R1078	B3	R136	C2	R169	C1	R199	C1	R322	B1	R371	B1	R454	B3	R492	B3	R5079	B3	R5138	B3	R522	C2
C1018	B3	C119	C2	C305	A1	C350	B1	C4029	B3	C444	A4	C491	B3	C510	C2	C5180	C3	CN202	B1	FB210	C2	IC304	B1	L409	A4	Q5008	A3	R1038	B2	R1079	B3	R137	C2	R170	B1	R200	C1	R323	B1	R372	B1	R455	B3	R493	A3	R5082	B3	R5139	B3	R523	B2
C1019	B3	C120	C2	C306	A1	C351	B1	C4030	B3	C453	C3	C492	B3	C5149	B3	C5181	B2	CN301AB1	FB211	C2	IC306	B1	L410	B4	Q5009	B2	R104	C1	R108	C2	R138	C2	R172	B1	R206	C1	R324	B1	R373	B1	R456	B3	R501	B2	R5085	B2	R515	C2	R525	B2	
C102	C1	C143	C1	C307	A1	C352	B1	C4031	B3	C454	C3	C493	B3	C515	C2	C5217	B3	CN302	B2	FB212	C2	IC402	C3	L411	B4	R1001	A1	R1040	C1	R1080	B3	R139	C2	R173	B1	R207	C1	R325	B1	R374	B1	R457	B3	R5017	B3	R5086	B2	R5151	A3	R526	B2
C1020	A2	C144	C1	C308	A1	C353	B1	C4032	B3	C455	C3	C496	B3	C5150	B3	C701	C2	CN5002A2	FB214	C2	IC403	C3	L412	A4	R1002	A1	R1041	B1	R109	C2	R140	B1	R179	C1	R208	C1	R326	B1	R375	B1	R458	C3	R502	B2	R5087	B2	R5152	B3	R527	B2	
C1021	B2	C146	C1	C309	B1	C354	B1	C4035	B3	C456	C3	C497	A4	C5151	B3	C702	C2	D1001	C2	FB302	A1	IC404	B3	L501	C2	R1004	C2	R1045	B3	R1091	A1	R144	B1	R180	B1	R209	B1	R345	A1	R376	B1	R459	C3	R5032	C3	R5088	B2	R5153	B3	R537	C2
C1026	B3	C150	B1	C310	B1	C355	B1	C4036	A3	C457	C3	C5011	A2	C516	C2	C704	C2	D1002	C1	FB303	A1	IC5006	C3	L502	C2	R1005	A1	R1046	B2	R1092	A1	R145	B1	R181	B1	R215	B1	R346	A1	R429	C3	R460	C3	R503A	B2	R509	C2	R5155	B3	R543	B3
C1027	B2	C251	A1	C311	A1	C356	B1	C4045	A3	C458	B1	C5017	B3	C5163	A3	C705	B2	D1004	C2	FB5002	B4	IC5007	B3	L606	C4	R1006	A1	R105	C1	R1093	A1	R146	B1	R182	B1	R260	B2	R348	A1	R431	C3	R461	C4	R504	B2	R5097	C3	R5156	A3	R547	B3
C1037	B2	C252	A1	C312	A1	C357	B1	C4080	B3	C460	C3	C5031	A3	C5164	C3	C801	A2	D1005	B1	FB5003	C4	IC501	B2	L607	B4	R1007	A1	R1052	C1	R1096	B2	R147	B1	R183	C2	R301	B1	R349	A1	R432	C3	R470	B3	R5040	A3	R5110	B3	R5158	A3	R554	B2
C1038	B2	C253	A1	C313	A1	C4006	B3	C4081	C3	C461	C4	C5032	B4	C5165	B3	C802	B2	D1006	C3	FB5004	C4	JK301	A1	Q1005	B3	R1009	A1	R1056	C3	R1097	C2	R148	B1	R184	C2	R302	B1	R351	A1	R433	C3	R471	B3	R5042	B3	R5111	C3	R5159	B3	R556	B2
C1039	B2	C254	A1	C314	A1	C4007	B3	C4082	C4	C470	B3	C5033	C4	C5166	A3	C803	B2	D201	C2	FB5005	C4	JK401	A4	Q1005	B3	R101	C1	R106	C1	R1098	C2	R149	C1	R185	B1	R303	B1	R352	A2	R434	C3	R472	B3	R5043	A3	R5113	C3	R5162	A2	R557	B2
C1040	A1	C255	A1	C318	B1	C4008	B3	C4083	C3	C471	B3	C5034	C4	C5167	B3	C804	B1	D202	C1	FB5006	B2	JP503	B4	Q1007	C3	R1010	A1	R1067	B1	R1099	C2	R152	C1	R186	B1	R308	A1	R354	B2	R435	C3	R474	B3	R5044	A3	R5114	C3	R5163	A2	R558	B2
C1041	C2	C256	A1	C323	B2	C4009	B3	C431	C3	C472	C3	C5035	C4	C5169	B3	C805	C2	D203	C1	FB5007	B2	L303	B2	Q105	C2	R1011	B1	R107	C2	R110	C1	R156	C1	R189	C1	R309	A2	R355	B1	R436	C3	R475	B3	R5045	A3	R5115	C3	R5165	C3	R801	C2
C1042	C3	C257	A1	C325	B1	C4010	B3	C432	C3	C473	C3	C5036	A3	C517	B2	C807	A2	D5005	A3	FB901	B1	L306	B2	Q105	C2	R1012	B1	R1070	B1	R1112	C2	R157	C1	R190	C1	R310	B1	R356	B2	R437	C3	R476	B3	R5046	B3	R5116	C3	R5168	C2	R802	B2
C1047	C2	C258	A1	C332	B1	C4011	B3	C433	C3	C474	C3	C5045	B3	C5170	B2	C808	B2	D5007	A3	FB903	B1	L401	C4	Q106	C1	R1014	A1	R1071	C3	R125	C1	R158	C1	R191	C1	R311	B1	R358	B1	R438	C3	R477	B3	R5049	A2	R5117	C3	R5183	C3	XL101	C1
C1048	B2	C2901	C1	C334	B1	C4012	B3	C434	C3	C475	C3	C5047	B3	C5171	B3	C809	B2	D5008	A3	FB904	C2	L402	C4	Q106	C1	R102	B2	R1072	C3	R127	B1	R159	C1	R192	C2	R312	B2	R359	B1	R439	C3	R478	B3	R505	C2	R5118	C3	R5184	C3	XL5001	B3
C1049	B2	C2902	B1	C342	A1	C4013	B3	C435	C3	C476	B3	C5048	B3	C5172	A3	CN1004B1	D5015	A3	IC1001	B2	L403	C4	Q107	C2	R1022	C1	R1073	B3	R128	B1	R162	B1	R193	C2	R313	B1	R360	B1	R440	C3	R479	B3	R5050	B3	R512	C2	R5185	B3	XL501	B2	
C109	C2	C2903	C2	C343	A2	C4014	B3	C436	C3	C477	B3	C5049	B3	C5174	B3	CN1005C2	D5017	A3	IC101	B1	L404	C4	Q107	C2	R1023	C1	R1074	B3	R129	B1	R165	B1	R194	C1	R316	B1	R367	B1	R449	C4	R480	B3	R506	C2	R513	C2	R5187	B3	ZD801	B3	
C114	C2	C2904	C1	C344	A1	C4015	B3	C437	C3	C478	B3	C5064	B3	C5175	A3	CN1006A1	D5018	A3	IC103	C1	L405	C4	Q5001	C2	R1026	C1	R1075	B3	R130	C2	R166	B1	R195	B1	R317	B1	R368	B1	R450	B3	R481	B3	R5064	A2	R5130	B3	R519	C2	ZD802	B2	
C115	C2	C2905	C1	C345	A1	C4018	B4	C438	C3	C482	C3	C5066	C3	C5176	A3	CN1007C3	D5019	A3	IC2901	C2	L406	B4	Q5002	C3	R1028	B1	R1076	B3	R134	C1	R167	C1	R196	B1	R320	B2	R369	B1	R452	B3	R482	B3	R5065	B2	R5131	B3	R520	C2			

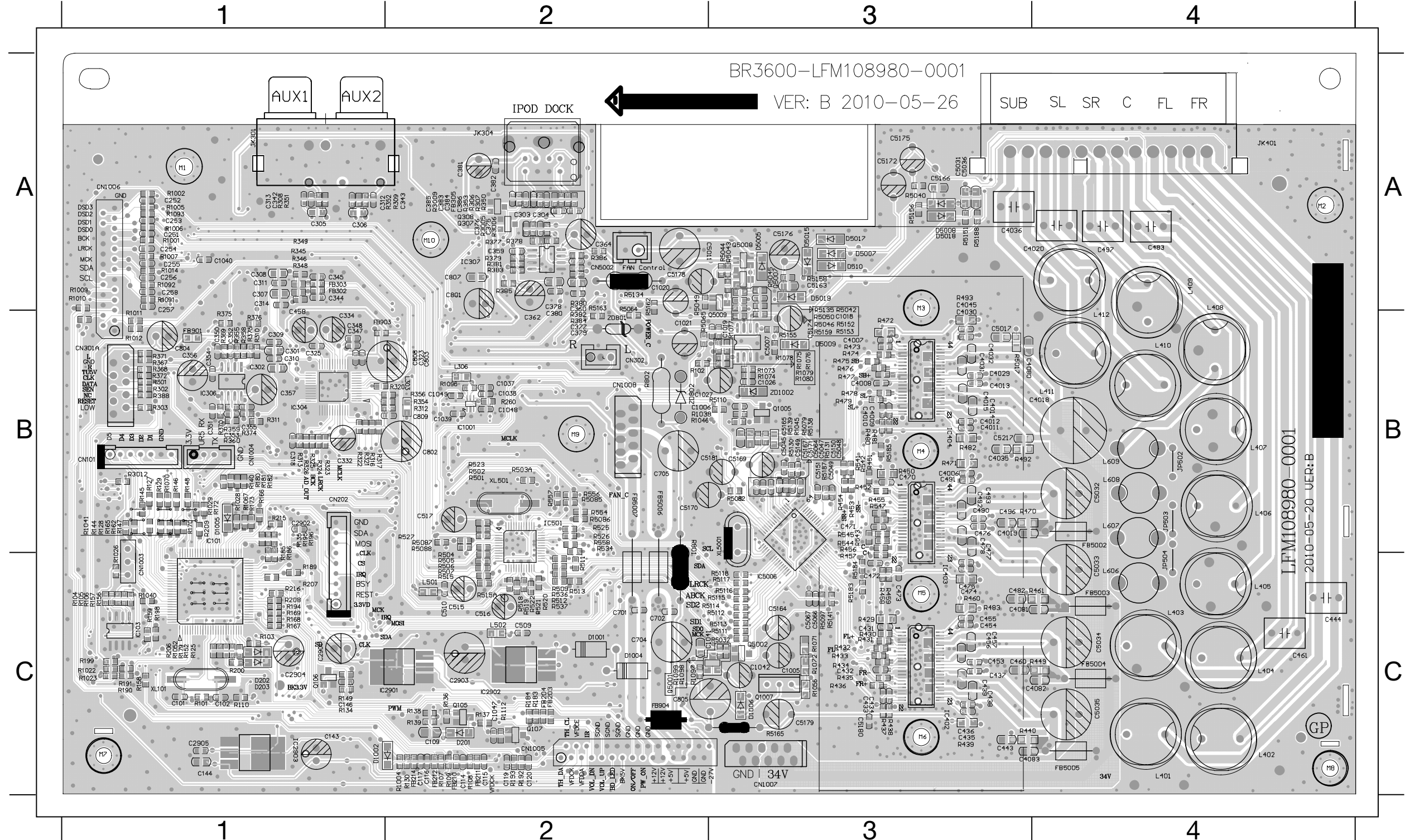

PCB LAYOUT - BOTTOM VIEW

7 - 4

7 - 4

C1008	A2	C1015	C3	C105	C1	C113	B1	C243	C1	C4001	A4	C4025	A4	C4042	A3	C462	C4	C485	B4	C5051	B3	C513	B2	C5157	C3	C589	C4	R1065	C3	R161	C1	R282	C3	R329	B2	R466	A4	R5065	B3	R5144AA4	R5282	A4	
C1009	C3	C1016	C3	C106	B1	C145	C1	C244	C1	C4002	A4	C4026	A4	C445	C4	C463	C4	C486	A4	C506	B2	C514	B2	C5158	C2	C590	B4	R1066	C3	R163	C1	R283	C2	R441	A4	R467	A4	R5083	C3	R5145	A4	R5284	A4
C1010	B1	C1022	A2	C107	C1	C147	C1	C245	C1	C4003	A4	C4037	A4	C446	C4	C464	C4	C487	A4	C5065	B3	C5152	B3	C5159	C2	C703	C2	R150	C1	R164	B1	R284	C3	R442	A4	R484	A4	R5084	C3	R5148	A4	R535	C2
C1011	A2	C1023	A2	C108	B1	C148	C1	C317	B1	C4021	A4	C4038	A3	C447	C4	C465	C4	C498	B4	C507	B2	C5153	B3	C5160	C3	C806	B1	R151	C1	R171	B1	R318	C1	R445	A4	R485	A4	R510	B2	R5148AA4	R552	B2	
C1012	A2	C1024	B1	C110	B1	C149	B1	C319	B1	C4022	B4	C4039	A4	C448	C4	C466	A4	C499	A4	C508	C2	C5154	C2	C5161	C3	L503	B2	R153	C1	R174	B1	R319	C1	R446	A4	R488	A3	R5133	B3	R5149	A3	R553	B2
C1013	A2	C103	C1	C111	B1	C241	B1	C324	B1	C4023	A4	C4040	A3	C449	A4	C467	A4	C502	B2	C511	C2	C5155	C3	C5168	B3	Q101	C1	R154	B1	R175	C1	R327	B2	R462	A4	R489	A3	R5140	B3	R524	B2		
C1014	B1	C104	C1	C112	B1	C242	B1	C4000	B4	C4024	B4	C4041	A3	C450	A4	C484	C4	C503	B2	C512	B2	C5156	C2	C5223	B3	R1027	B1	R160	C1	R178	C1	R328	B2	R463	A4	R503	B2	R5144	A4	R5281	A4		

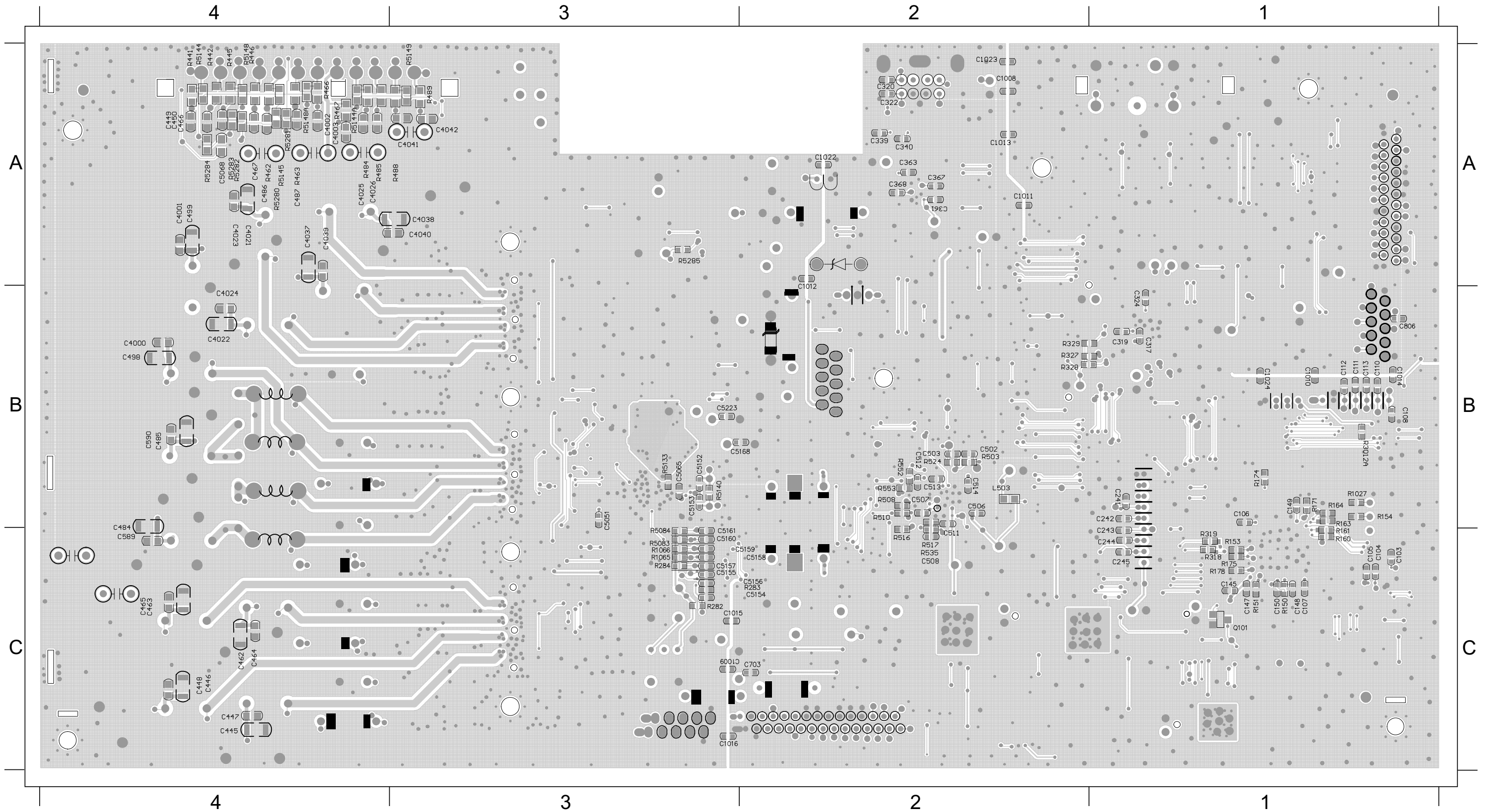

POWER BOARD

TABLE OF CONTENTS

Internal IC Diagram 8-1
 Circuit Diagram 8-2
 PCB Layout Top View 8-3
 PCB Layout Bottom View 8-4

8 - 1
INTERNAL IC DIAGRAM - SSC620S SOP

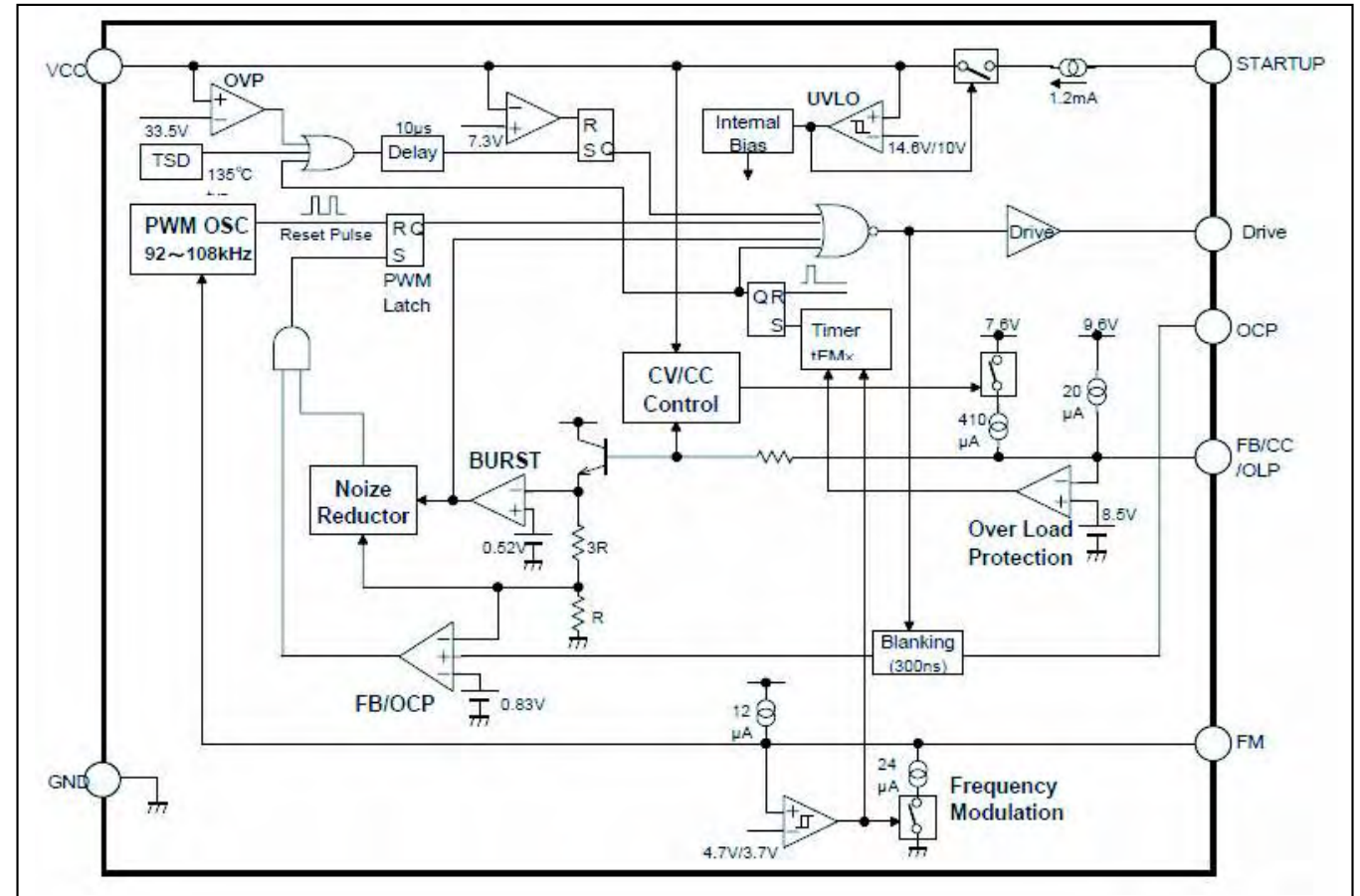

INTERNAL IC DIAGRAM - AZ7500BP

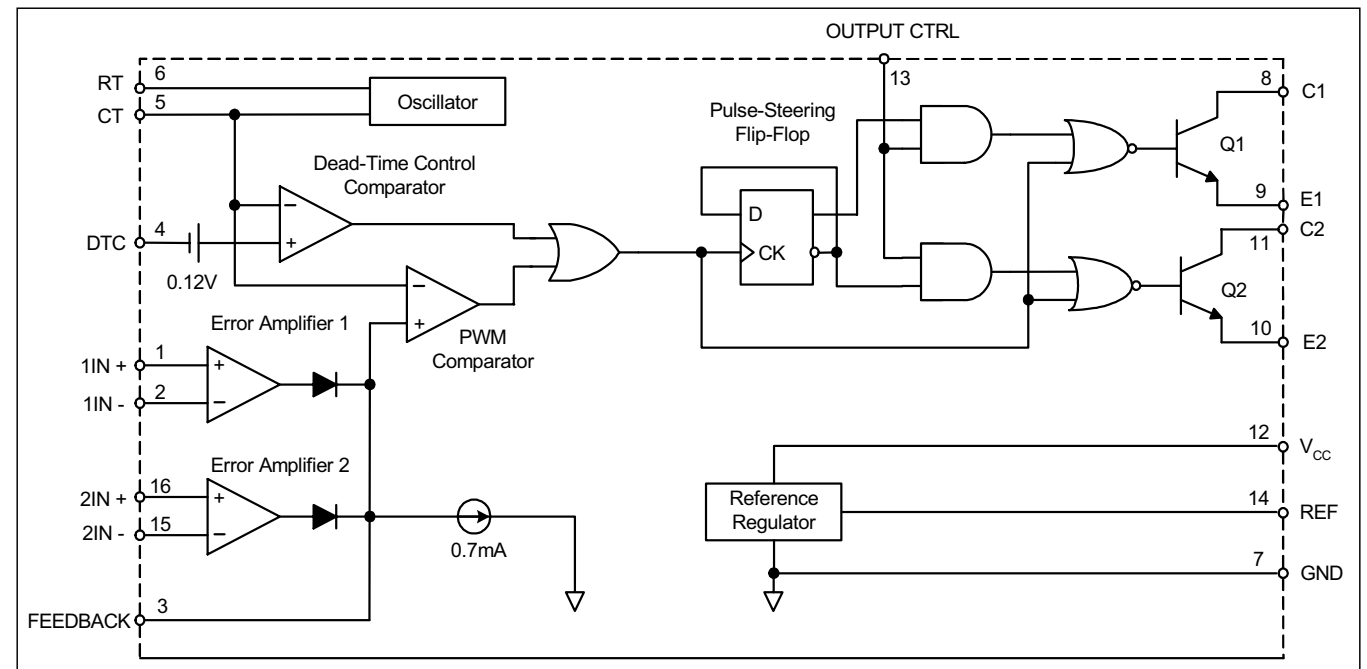

CIRCUIT DIAGRAM

BD901	A1	C920	A1	C931	C3	C949	A2	C960	B3	C971	A3	C982	C1	CN905	C4	D917	A3	D931	B1	IC904	C2	Q902	C3	Q915	B3	R906	B1	R919	A4	R933	C2	R946	B4	R958	B3	R969	A3	R981	B3	R995	B4	ZD902	C2
C901	C1	C921	A1	C935	C2	C950	A2	C961	B3	C972	A3	C983	C3	CN906	A4	D918	B1	D932	B4	IC905	B3	Q903	B4	Q917	C3	R907	A1	R920	C2	R935	C2	R947	C3	R959	B3	R970	A4	R982	C4	R996	C3	ZD903	B2
C902	C1	C922	C2	C936	B2	C951	A2	C962	B3	C973	C3	C984	C4	D903	C2	D919	C2	D933	B4	L901	B1	Q904	C3	Q918	C3	R908	A1	R921	C2	R936	C2	R948	C3	R960	A4	R971	A3	R983	C4	R997	B4	ZD904	A2
C904	A1	C923	C2	C938	C1	C952	A2	C963	B3	C974	B4	C991	B3	D904	B2	D920	C2	D935	C4	L902	B1	Q906	B3	Q919	B4	R909	A1	R923	C3	R937	B2	R949	A1	R961	B3	R972	A3	R984	C3	R998	B4	ZD905	A3
C905	A1	C924	C2	C940	B1	C953	B4	C964	B3	C975	B4	C992	B4	D905	B2	D921	B2	F901	C1	L904	B3	Q907	C3	Q919	B4	R910	A1	R925	C3	R938	B2	R950	C3	R962	C2	R973	A3	R985	C3	R999	B4	ZD907	A4
C912	C1	C925	C2	C941	C2	C954	C3	C965	C3	C976	C3	C993	B4	D906	A2	D922	B2	GT902	B1	L905	B3	Q909	C2	Q920	C4	R911	B3	R926	A3	R940	B1	R952	B3	R963	B3	R975	A3	R989	C3	T901	B2	ZD908	A3
C913	C3	C926	C2	C943	A2	C955	B3	C966	B3	C977	B2	C994	A1	D907	A2	D924	A3	GT903	C2	L906	C3	Q910	B2	R901	B1	R912	B1	R927	C2	R941	B1	R953	A3	R964	B3	R976	A3	R990	C3	T902	B2	ZD909	A3
C915	B1	C927	B3	C944	A2	C956	C2	C967	B3	C978	B2	C998	C4	D908	B2	D926	A3	GT904	B2	L907	A2	Q911	A2	R902	B1	R915	C2	R928	C2	R942	B2	R954	C2	R965	B3	R977	B4	R991	C3	T903	A2	ZD910	A3
C917	B1	C928	B3	C946	A2	C957	A3	C968	A3	C979	C2	CN901	C1	D909	A3	D927	A3	GT905	A2	L908	A3	Q912	A2	R903	B1	R916	A4	R929	C2	R943	B2	R955	C2	R966	B3	R978	B4	R992	C3	TVR901B1	ZD913	A3	
C918	B1	C929	B3	C947	C2	C958	A3	C969	A3	C980	B2	CN903	B4	D910	A3	D929	A3	IC901	C1	NTC901C1	Q913	A2	R904	B1	R917	A4	R930	C2	R944	A2	R956	B3	R967	A3	R979	C4	R993	C3	TVR902A1	ZD920	C4		
C919	B1	C930	A4	C948	B2	C959	A4	C970	A3	C981	B3	CN904	C4	D912	A3	D930	A1	IC902	C2	Q901	B3	Q914	B3	R905	B1	R918	A4	R932	A2	R945	A2	R957	B3	R968	A3	R980	C4	R994	C3	TVR903A1	ZD927	B4	

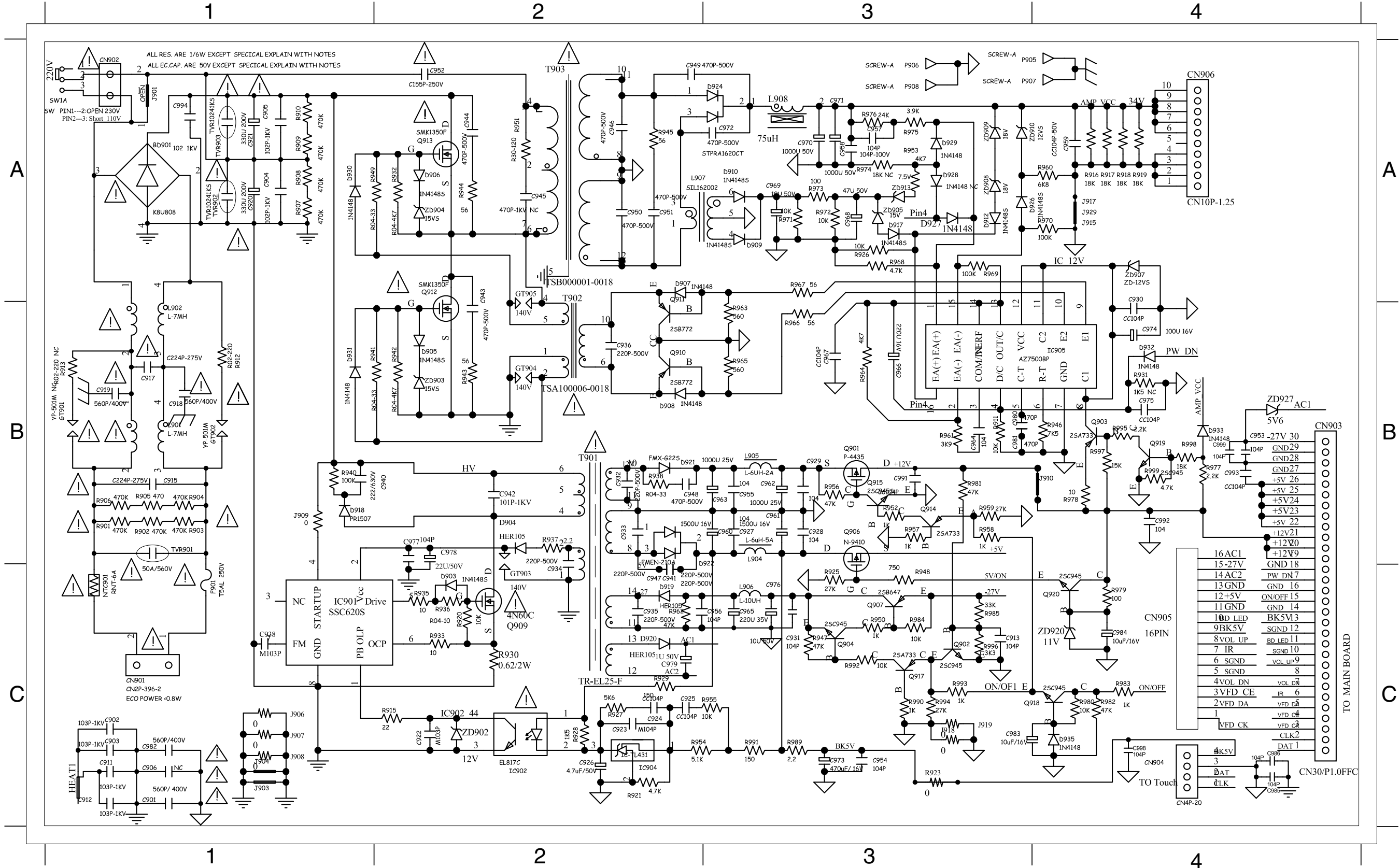

PCB LAYOUT - TOP VIEW

BD901 B4	C919 B4	C940 C3	C965 C2	C973 C1	C983 A1	CN906 A2	D922 B2	F901 A3	IC904 C2	J907 B3	J913 C1	J919 B1	J926 C1	L902 B4	NTC901A4	Q912 B3	R940 C3	R958 C1	R991 C1	TVR902C4
C901 A2	C921 C4	C952 B3	C966 B1	C974 C1	C984 B1	D904 C3	D924 B2	GT902 A4	IC905 B2	J908 C3	J914 C1	J920 B1	J927 B1	L904 C1	Q903 B1	Q913 B3	R941 B3	R977 A1	R993 C1	TVR903C4
C902 A3	C922 C3	C960 C2	C968 B2	C976 C2	CN901 A4	D918 C3	D926 B2	GT903 C3	J903 B3	J909 C3	J915 C1	J921 B1	J928 B1	L905 C1	Q907 C1	R912 B4	R943 B3	R978 B1	T901 C3	
C915 A4	C923 C2	C961 C1	C969 B2	C978 C3	CN903 A1	D919 C2	D930 B3	GT904 B3	J904 B3	J910 B1	J916 C1	J923 C2	J929 B1	L906 C2	Q909 C3	R929 C2	R944 B3	R981 C1	T902 B2	
C917 B4	C926 C2	C962 C1	C970 A2	C979 C2	CN904 C1	D920 C2	D931 B3	GT905 B3	J905 B4	J911 B1	J917 C2	J924 C2	J930 A1	L907 B2	Q910 B2	R930 C3	R945 A2	R985 C2	T903 A2	
C918 B4	C938 C3	C963 C1	C971 A1	C982 C2	CN905 C1	D921 C2	D932 B1	IC904 C2	J906 B3	J912 B1	J918 C2	J925 C2	L901 B4	L908 A1	Q911 B2	R935 C3	R949 B3	R989 C1	TVR901A4	

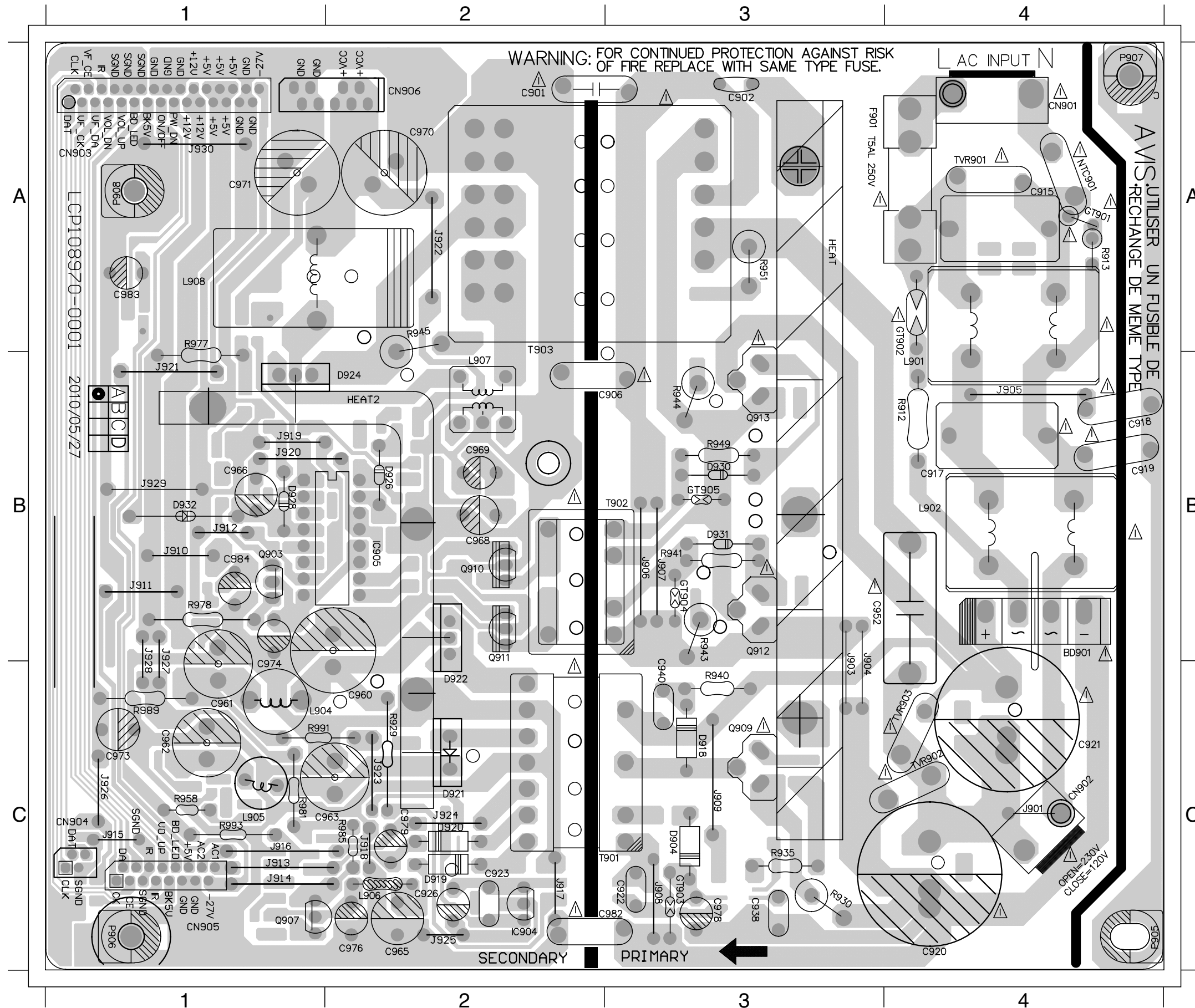

PCB LAYOUT - BOTTOM VIEW

8 - 4

8 - 4

C904	C4	C928	B1	C943	B3	C951	A2	C959	A2	C981	B1	C998	C1	D910	B2	IC901	C3	Q914	C1	R902	A4	R909	C4	R919	A2	R926	B2	R938	C2	R953	B1	R961	B1	R968	B1	R976	A1	R992	C1	ZD902	C3	ZD910	B2
C905	C4	C929	C1	C944	B3	C953	A2	C964	B2	C982	A1	D903	C3	D912	B2	IC902	C3	Q915	C1	R903	A4	R910	C4	R920	C3	R927	C2	R942	B3	R954	C2	R962	C2	R969	B2	R979	B1	R994	C1	ZD903	B3	ZD913	B2
C912	C3	C930	B1	C946	A2	C954	A1	C967	B2	C991	A1	D905	B3	D917	B2	J922	C2	Q917	C1	R904	A4	R911	B1	R921	C2	R928	C2	R946	B1	R955	C2	R963	B2	R970	B2	R980	A1	R995	B1	ZD904	B3	ZD920	B1
C913	C2	C931	C2	C947	B2	C955	C1	C972	A1	C992	C1	D906	B3	D927	B4	Q901	C1	Q918	A1	R905	A4	R915	C3	R922	B1	R932	B3	R947	C1	R956	C1	R964	B1	R971	B2	R982	A1	R996	C1	ZD905	B2	ZD927	C1
C924	C2	C935	C2	C948	C2	C956	C2	C975	B1	C993	A1	D907	B2	D929	B1	Q902	C2	Q919	B1	R906	A4	R916	A2	R923	C1	R933	C3	R948	B1	R957	C1	R965	B2	R972	B2	R983	A1	R997	B1	ZD907	B2		
C925	C2	C936	B2	C949	A1	C957	A1	C977	C3	C994	B3	D908	B2	D933	A1	Q904	C1	Q920	B1	R907	C4	R917	A2	R924	C1	R936	C3	R950	C1	R959	C1	R966	B2	R973	B2	R984	C1	R998	B1	ZD908	B2		
C927	B1	C941	B2	C950	A2	C958	A1	C980	B1	C997	C1	D909	B2	D935	A1	Q906	B1	R901	A4	R908	C4	R918	A2	R925	B1	R937	C3	R952	C1	R960	B2	R967	B2	R975	A1	R990	C1	R999	B1	ZD909	B2		

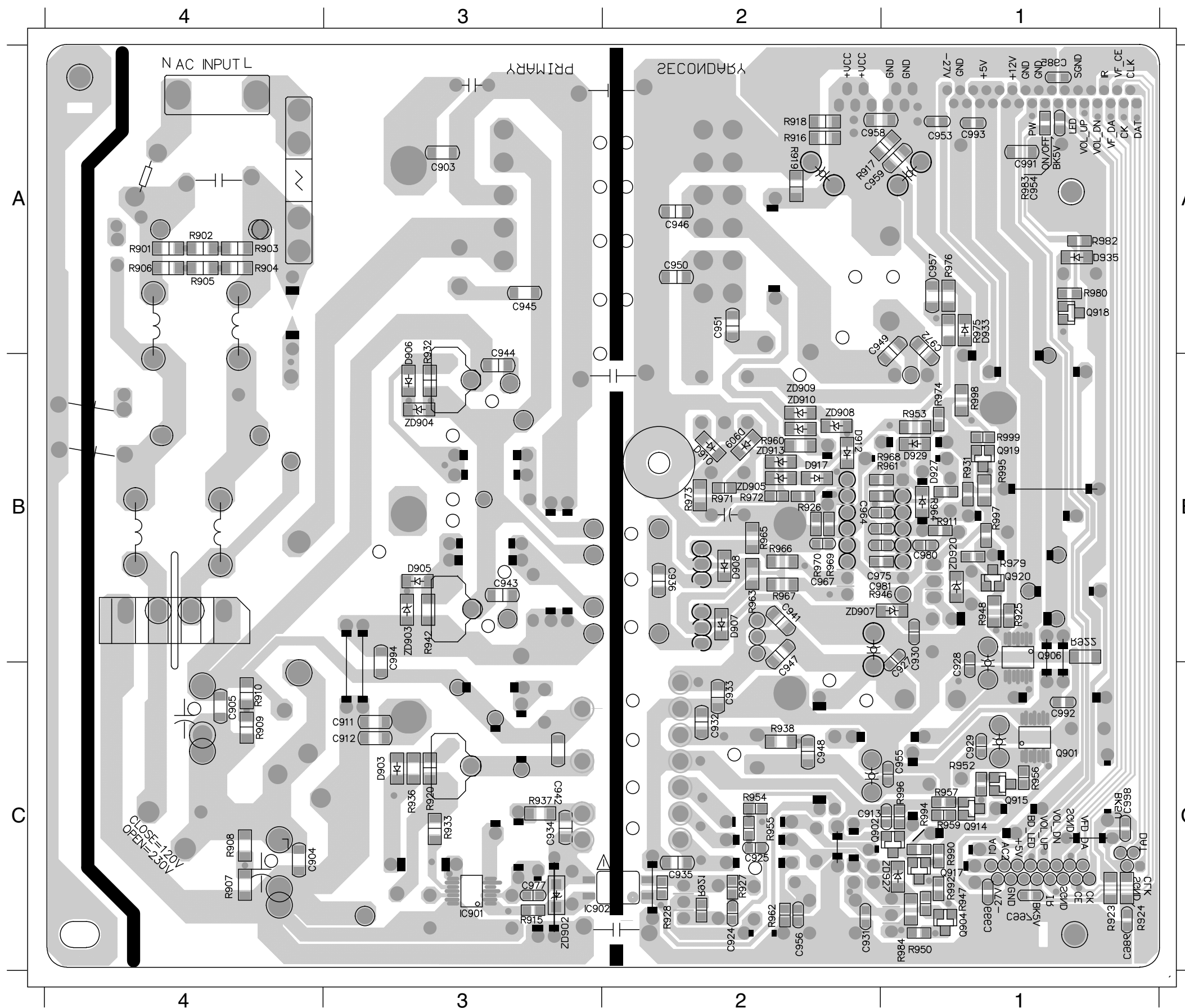

BD BOARD

TABLE OF CONTENTS

Circuit Diagram (one) 9-2
Circuit Diagram (two) 9-3
Circuit Diagram (three) 9-4
Circuit Diagram (four) 9-5
Circuit Diagram (five) 9-6
Circuit Diagram (six) 9-7
Circuit Diagram (seven) 9-8
Circuit Diagram (eight) 9-9
Circuit Diagram (nine) 9-10
Circuit Diagram (ten) 9-11
Circuit Diagram (eleven) 9-12
Circuit Diagram (twelve) 9-13
PCB Layout Top View 9-14
PCB Layout Bottom View 9-15

CIRCUIT DIAGRAM (one)

C1	A3	C20	B3	C31	C1	C6	C1	C966	B2	CB12	A3	CE19	A2	CE23	B2	CE9	C3	FB705	A1	FB719	B3	FB738	B2	Q518	B2	Q9	B1	R29	A3	R40	B1	R472	A2	R477	B2	U1	A3	U908	B2				
C15	B1	C23	B1	C32	C2	C960	A2	C971	B2	CB13	A1	CE2	A3	CE24	B3	CN4	A1	FB710	B1	FB722	B3	FB742	A1	Q519	B2	R24	A3	R30	B1	R41	C2	R473	A2	R478	B2	U3	A1						
C16	B1	C27	B1	C33	C2	C961	A2	C975	C2	CB14	C3	CE20	A2	CE26	C2	D201	C2	FB712	B2	FB723	B3	FB743	A1	Q6	A3	R26	A3	R31	B1	R42	C2	R474	A2	R479	B2	U5	B1						
C19	A3	C3	C1	C4	C2	C962	A2	CB10	A2	CE1	A3	CE21	A2	CE6	C2	D202	B1	FB717	B3	FB733	A2	L3	C2	Q7	A3	R27	A3	R32	B1	R43	C2	R475	A2	R6	C2	U6	C2						
C2	A3	C30	B1	C5	C1	C965	B3	CB11	A2	CE18	A2	CE22	A1	CE8	B3	D456	A2	FB718	B3	FB734	A2	L459	A2	Q8	B1	R28	A3	R35	B1	R471	A2	R476	B2	R672	C2	U907	A2						

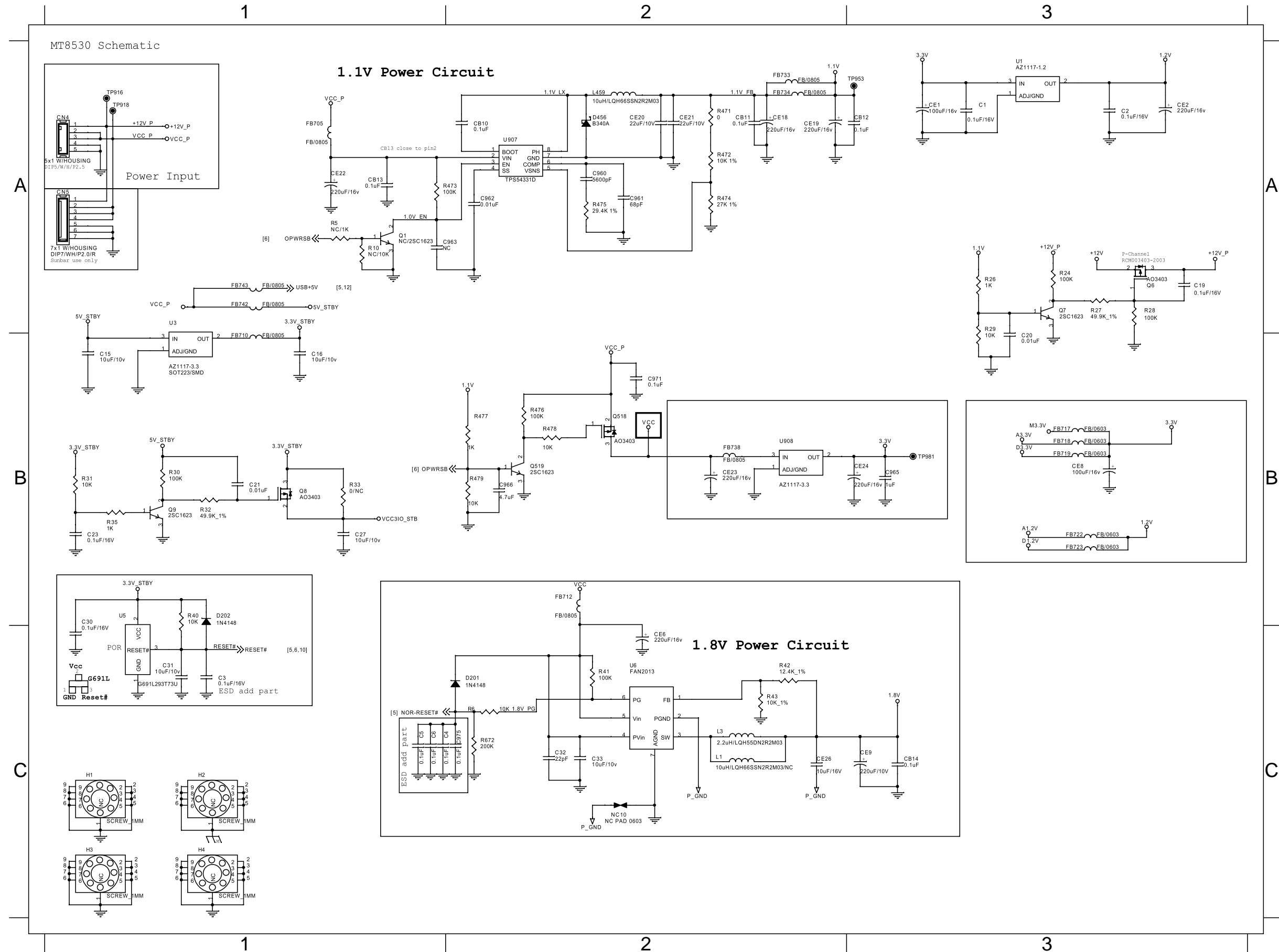

CIRCUIT DIAGRAM (two)

C100 A1 C104 A2 C108 A1 C112 A2 C116 A2 C120 A1 C124 A2 C128 A2 C132 A1 C136 B2 C140 B3 C144 B3 C148 C3 C152 C2 C970 C2 R101 B3 R105 B3 RN100 B3 RN104 C3 U102 A3
 C101 A2 C105 A2 C109 A1 C113 A2 C117 A1 C121 A2 C125 A2 C129 A1 C133 B2 C137 B2 C141 B3 C145 C3 C149 B2 C153 C2 CE25 C2 R102 B3 R106 C2 RN101 B3 RN105 C3 U103 C2
 C102 A2 C106 A2 C110 A2 C114 A2 C118 A1 C122 A2 C126 A2 C130 A1 C134 B2 C138 B3 C142 B3 C146 C3 C150 B2 C155 C1 FB100 C1 R103 B3 R108 C2 RN102 B3 U100 C1
 C103 A2 C107 A2 C111 A2 C115 A2 C119 A1 C123 A2 C127 A2 C131 A1 C135 B2 C139 B3 C143 B3 C147 C3 C151 C2 C156 C2 R100 B3 R104 B3 R109 C2 RN103 B3 U101 A3

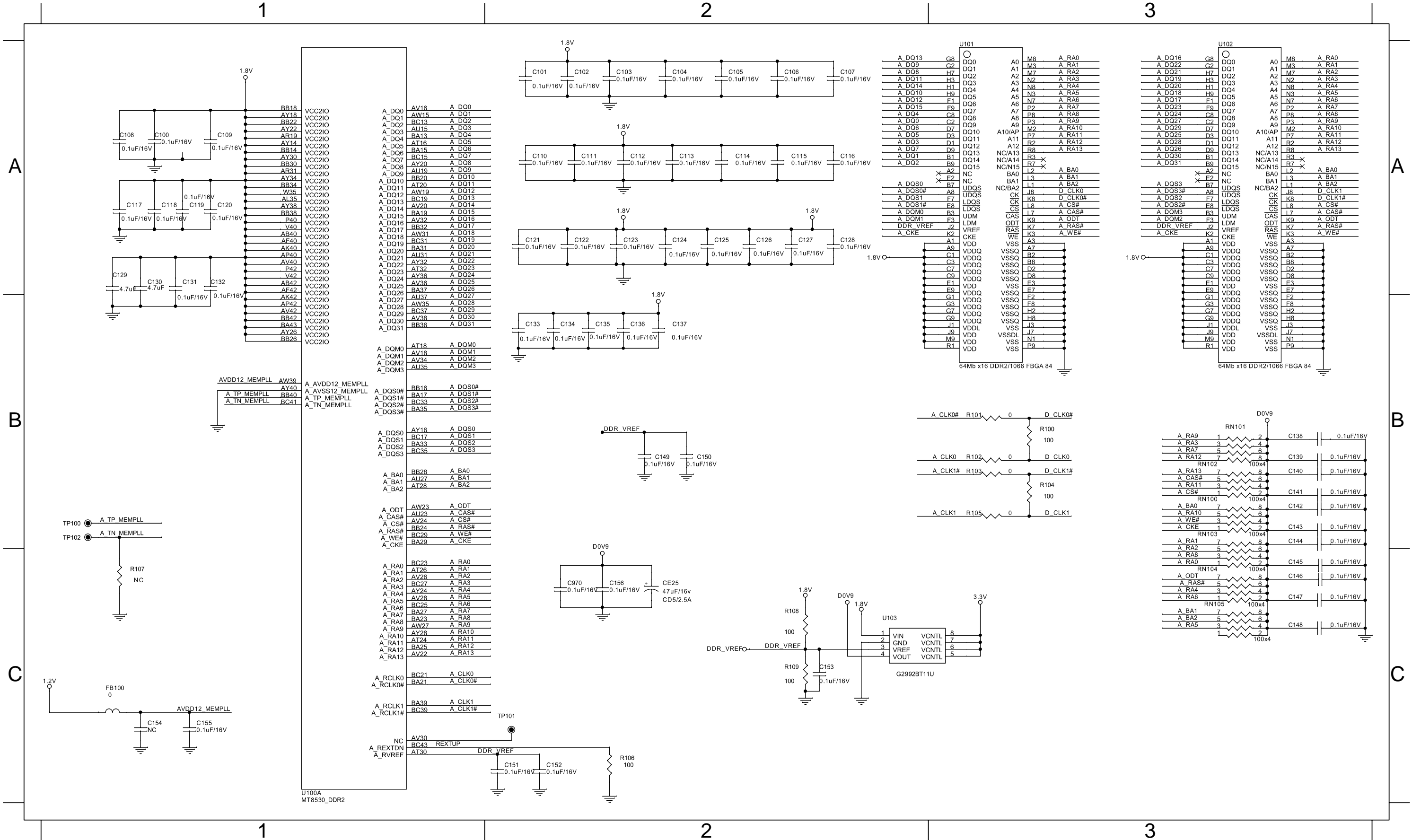

CIRCUIT DIAGRAM (three)

C200 C2 C203 A2 C206 A2 C209 A2 C212 A2 C215 A2 C218 A2 C221 B3 C224 B2 C227 B3 C230 B3 C233 B3 C236 B3 C239 C1 R202 B2 R205 B2 RN201 B3 RN204 B3 U202 A3
 C201 A1 C204 A2 C207 A1 C210 A2 C213 A1 C216 A2 C219 A2 C222 B3 C225 B3 C228 B3 C231 B3 C234 B2 C237 C3 R200 B2 R203 B2 R206 C1 RN202 B3 RN205 B3
 C202 A1 C205 A2 C208 A1 C211 A2 C214 A1 C217 A2 C220 A2 C223 B3 C226 B3 C229 B3 C232 B3 C235 B2 C238 C2 R201 B2 R204 B2 RN200 B3 RN203 B3 U201 A2

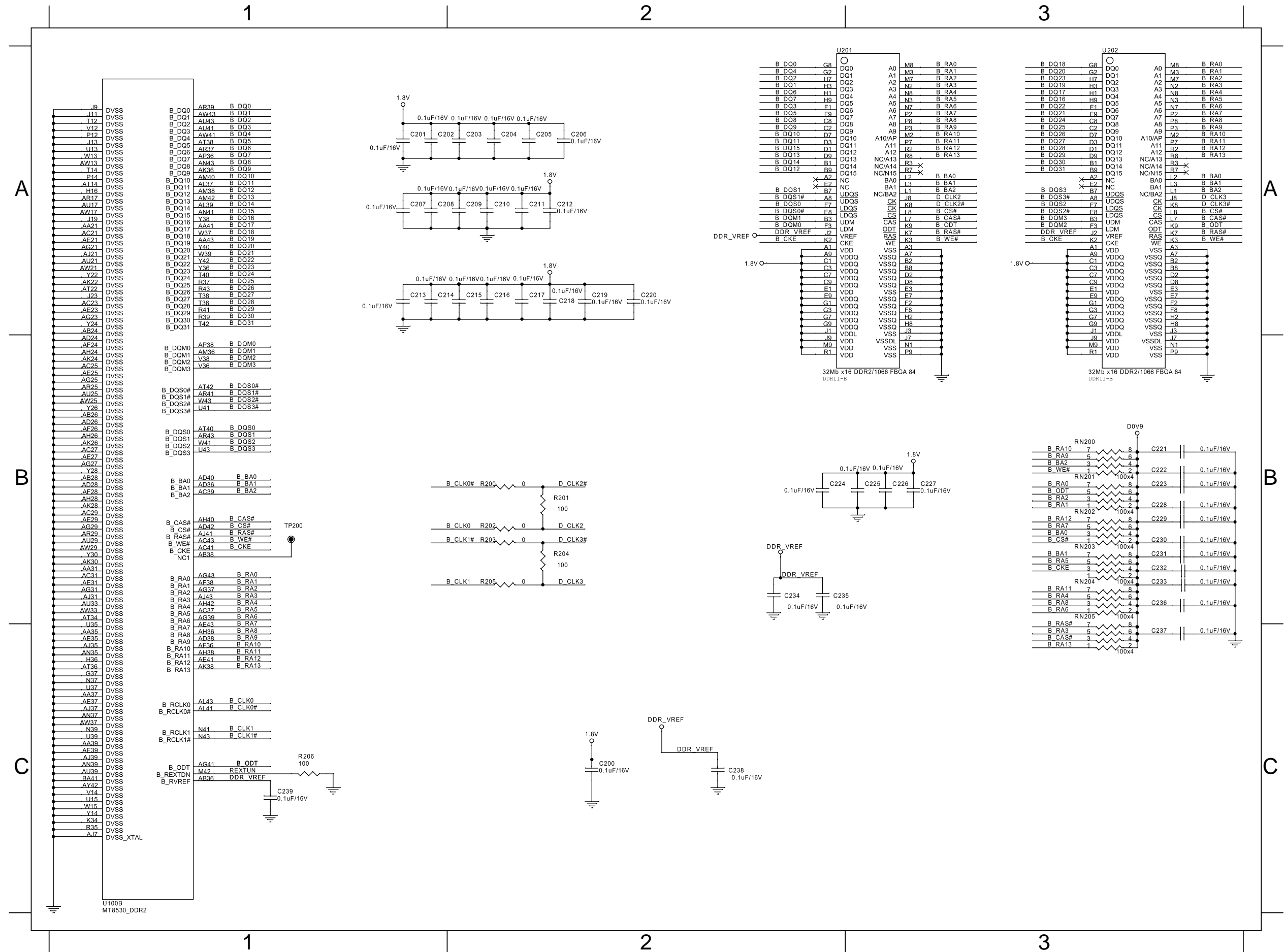

CIRCUIT DIAGRAM (four)

C300 B2 C308 A1 C313 A2 C318 B3 C325 B1 C330 B2 C336 C3 C909 C2 CB1 B3 FB302 A1 FB306 B3 FB310 B1 Q300 B3 R302 A2 R306 B3 R312 B2 R316 B3 R321 C3 R331 C2 R335 C2 R484 B3 Y300 B1
 C302 A1 C309 A3 C315 B1 C319 B1 C326 B1 C332 B1 C906 C2 C910 C2 CB2 B3 FB303 A1 FB307 B3 FB311 B1 Q301 C3 R303 B3 R308 B3 R313 B3 R317 C2 R322 C3 R332 C2 R336 C2 R485 B2 Y301 C1
 C304 A1 C310 A3 C316 B2 C321 B1 C328 B1 C334 C1 C907 C2 C911 C2 FB300 A1 FB304 A1 FB308 B1 FB312 C1 Q517 C3 R304 B1 R309 B3 R314 B2 R319 C2 R323 C3 R333 C2 R482 B3 R673 B3
 C306 A1 C312 A1 C317 B3 C322 B1 C329 B2 C335 C1 C908 C2 C967 C2 FB301 A1 FB305 A1 FB309 B1 J300 A3 R300 B2 R305 B1 R310 B3 R315 B3 R320 C1 R330 C2 R334 C2 R483 B3 U300 B3

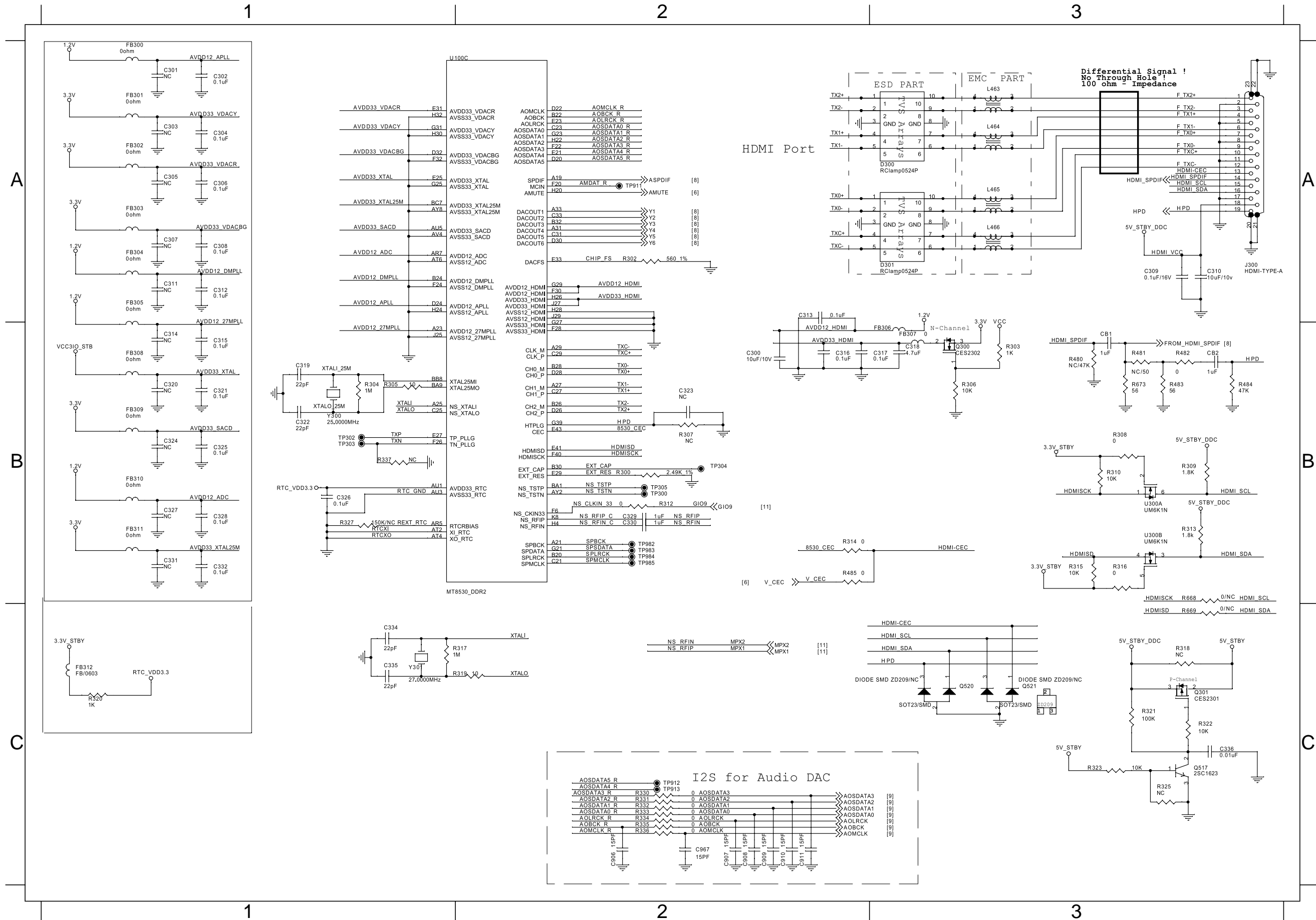

CIRCUIT DIAGRAM (five)

C350	B3	C355	A3	C359	A1	C366	B3	C374	B3	CB3	B2	CE10	B2	FB352	A1	FB356	A2	J351	C2	R326	B2	R354	A3	R360	B1	R368	B1	R375	C3	R381	C3	R418	C2	R488	B2	U905	B2
C351	A2	C356	A1	C361	A2	C367	B3	C375	B3	CB4	C2	CE11	C2	FB353	A1	FB357	B2	J903	C2	R350	A2	R355	A3	R363	C1	R369	B1	R376	C3	R415	C1	R427	A1	R489	C2	ZD2	C2
C353	A1	C357	A1	C363	A2	C368	B2	C376	B3	CB8	B2	FB350	A1	FB354	A2	FB724	B2	Q401	C1	R351	A2	R358	B1	R365	C1	R370	B1	R377	C3	R416	C2	R486	B2	RN350	B1		
C354	A1	C358	A3	C364	B2	C370	B3	C377	B3	CB9	B2	FB351	A1	FB355	A2	FB725	C2	Q402	C2	R352	A3	R359	B1	R367	B1	R373	C3	R378	B1	R417	C1	R487	B2	U351	A3		

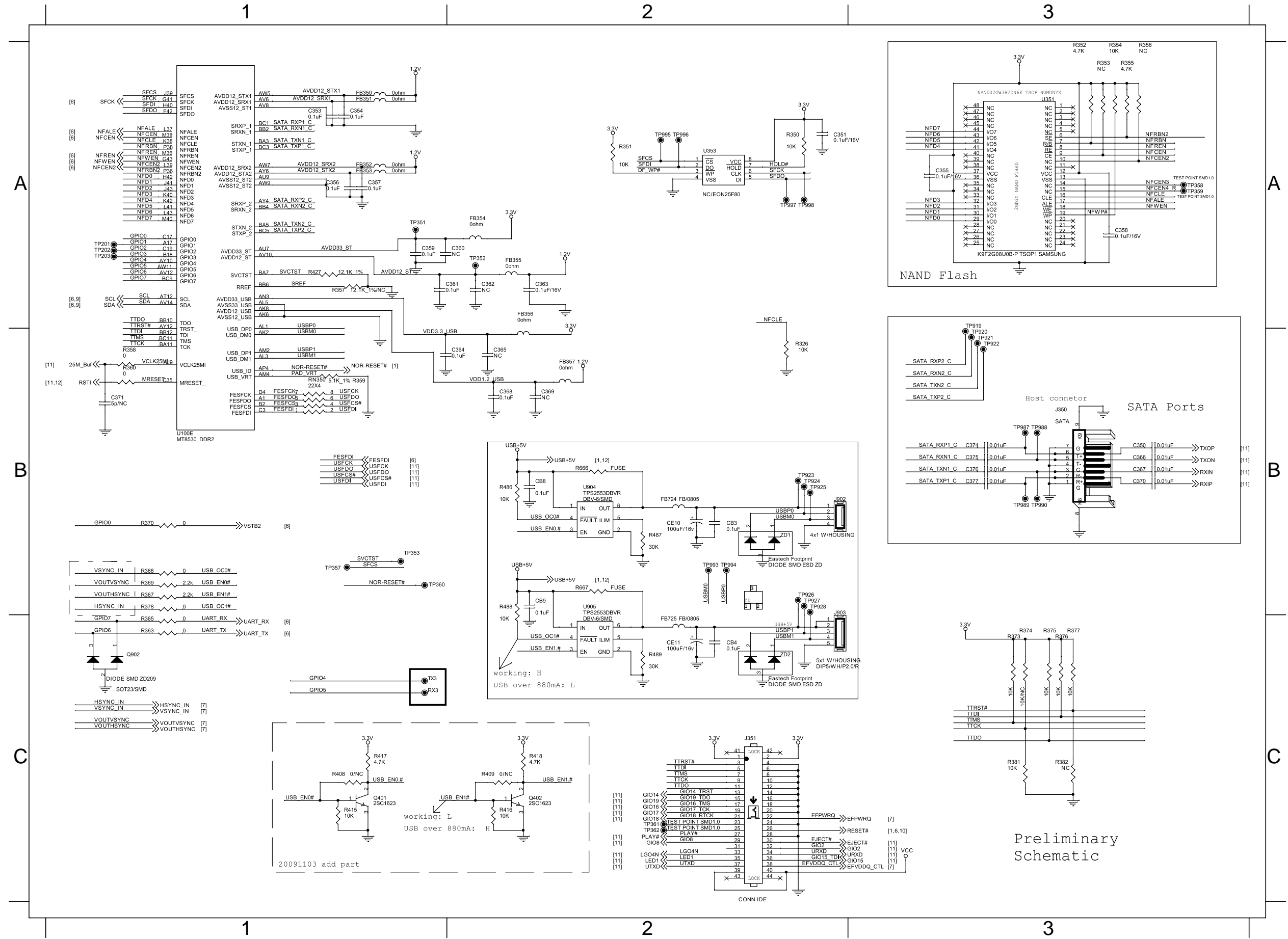

Preliminary Schematic

CIRCUIT DIAGRAM (six)

C386 B1 C389 B3 FB358 A1 FB360 B3 J355 B3 R393 A2 R397 A1 R399 A3 R401 B2 R404 B3 R407 B2 R419 B2 R424 C1 R496 C2 R677 C2
 C388 B1 C956 C3 FB359 A1 HA501 C2 Q901 C4 R394 A3 R398 A3 R400 A2 R402 B2 R405 B3 R412 C2 R423 C1 R495 C2 R497 C2

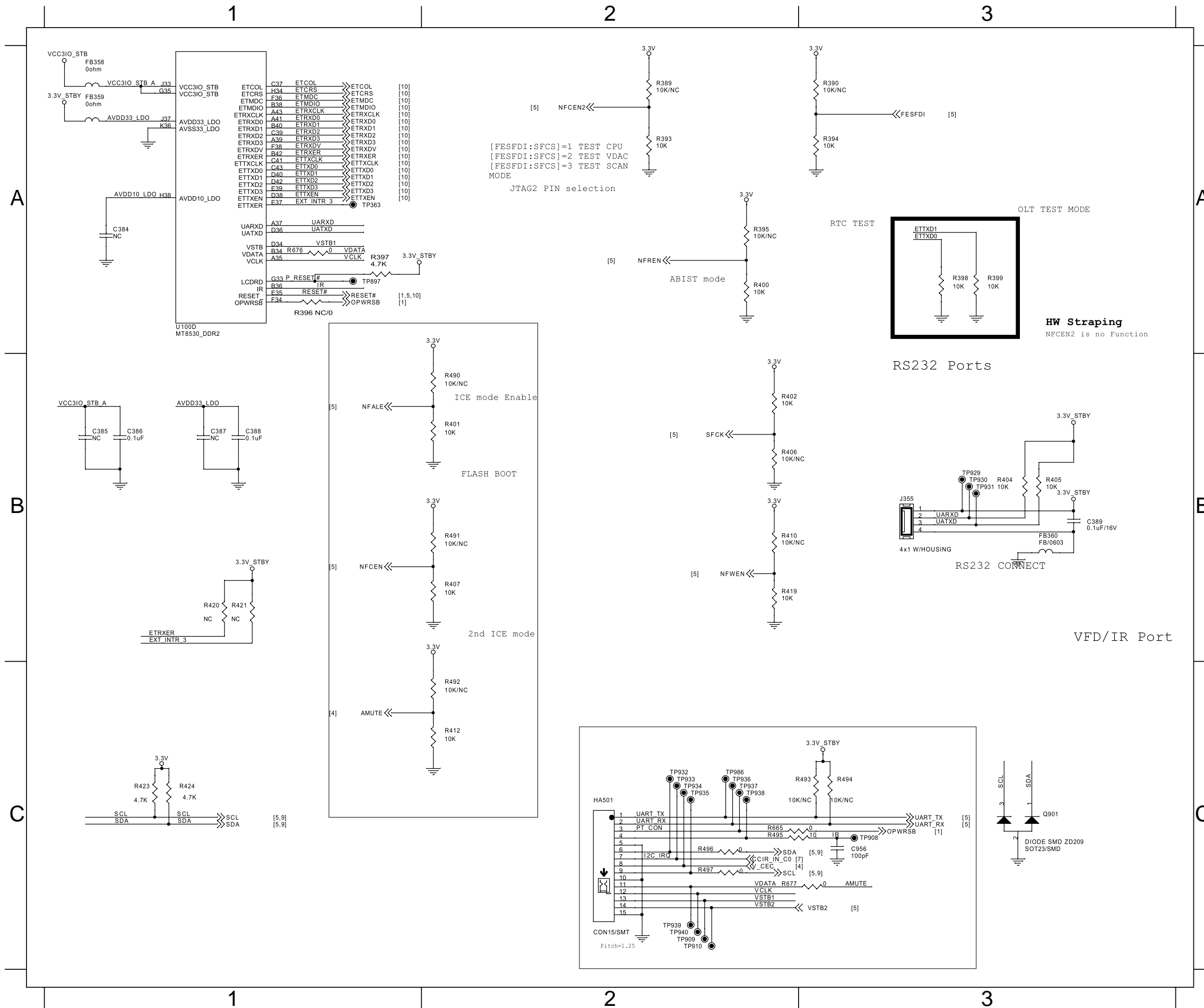

CIRCUIT DIAGRAM (seven)

C390 B1 C392 B2 C394 B2 C396 B1 C398 B1 C400 B2 C402 C1 C404 C1 C406 C2 C408 C1 C410 C1 C412 C2 C414 C1 C416 C1 C418 C1 C420 C1 C422 C1 C424 C1 R425 A2
 C391 B2 C393 B2 C395 B1 C397 B1 C399 B1 C401 C1 C403 C1 C405 C1 C407 C1 C409 C1 C411 C1 C413 C1 C415 C1 C417 C1 C419 C1 C421 C1 C423 C1 FB361 A1 R426 B1

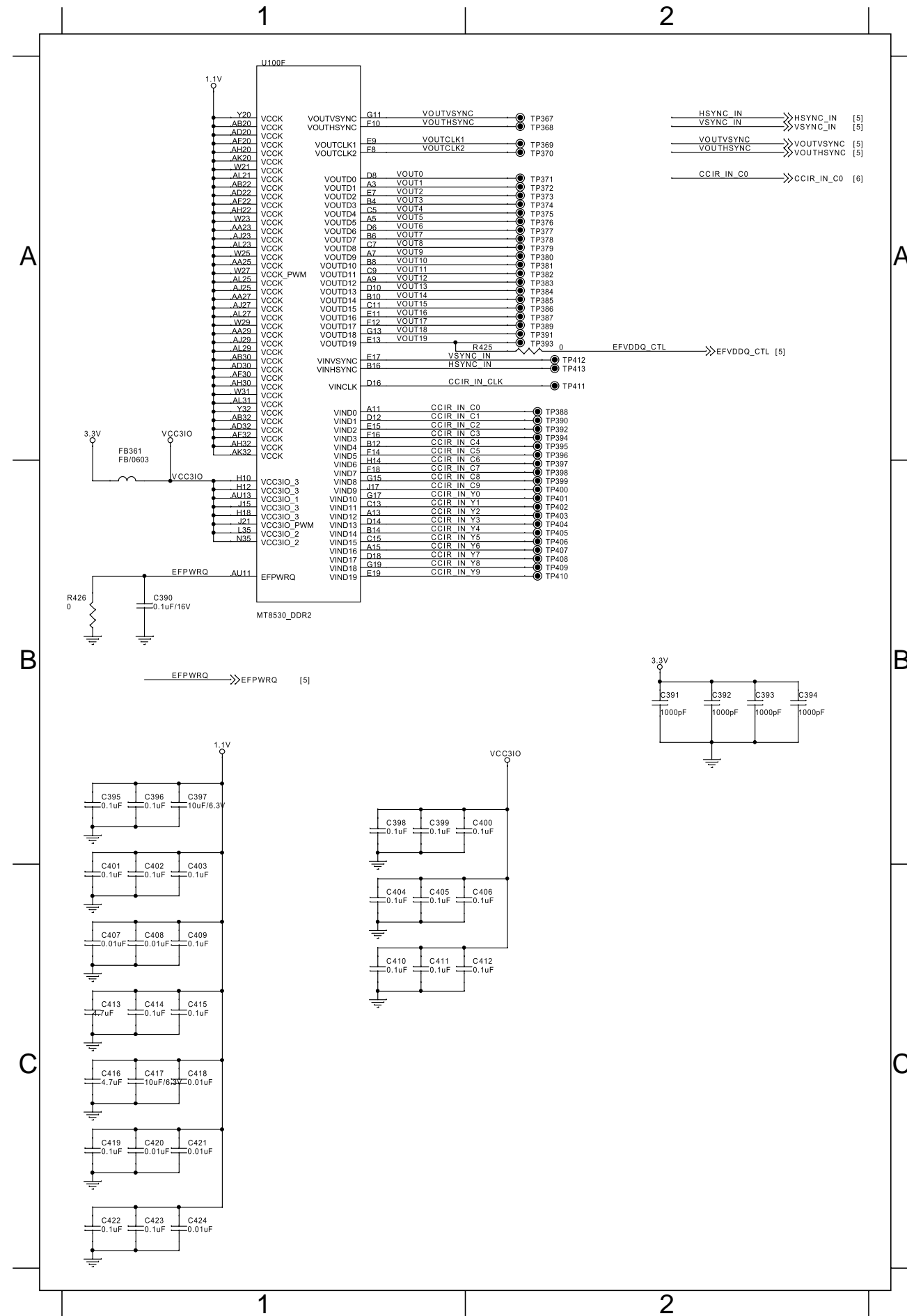

CIRCUIT DIAGRAM (eight)

C455 B1 C459 A1 C463 A1 C465 B1 C501 B3 CN203 A3 D451 B2 D455 A2 L450 A1 L453 A1 P501 B3 Q511 A2 Q513 A2 R455 B1 R467 A1 R559 B3
 C456 B1 C460 A1 C464 A1 C466 B1 CB5 A3 D450 A2 D454 A2 FB501 B3 L451 B1 L455 A1 P502 B3 Q512 A2 Q514 B2 R461 A1 R470 A1

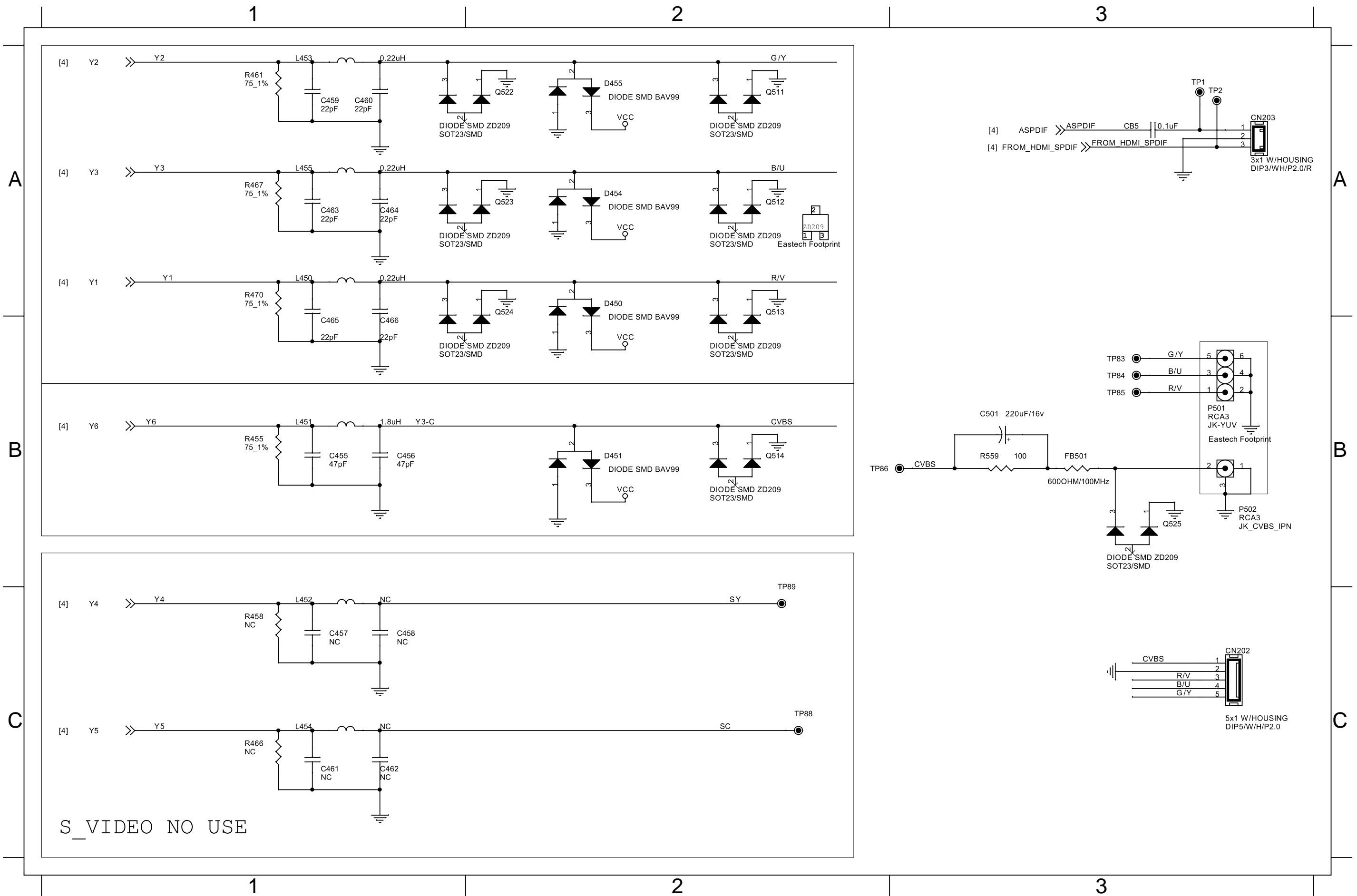

CIRCUIT DIAGRAM (nine)

HA500 A3

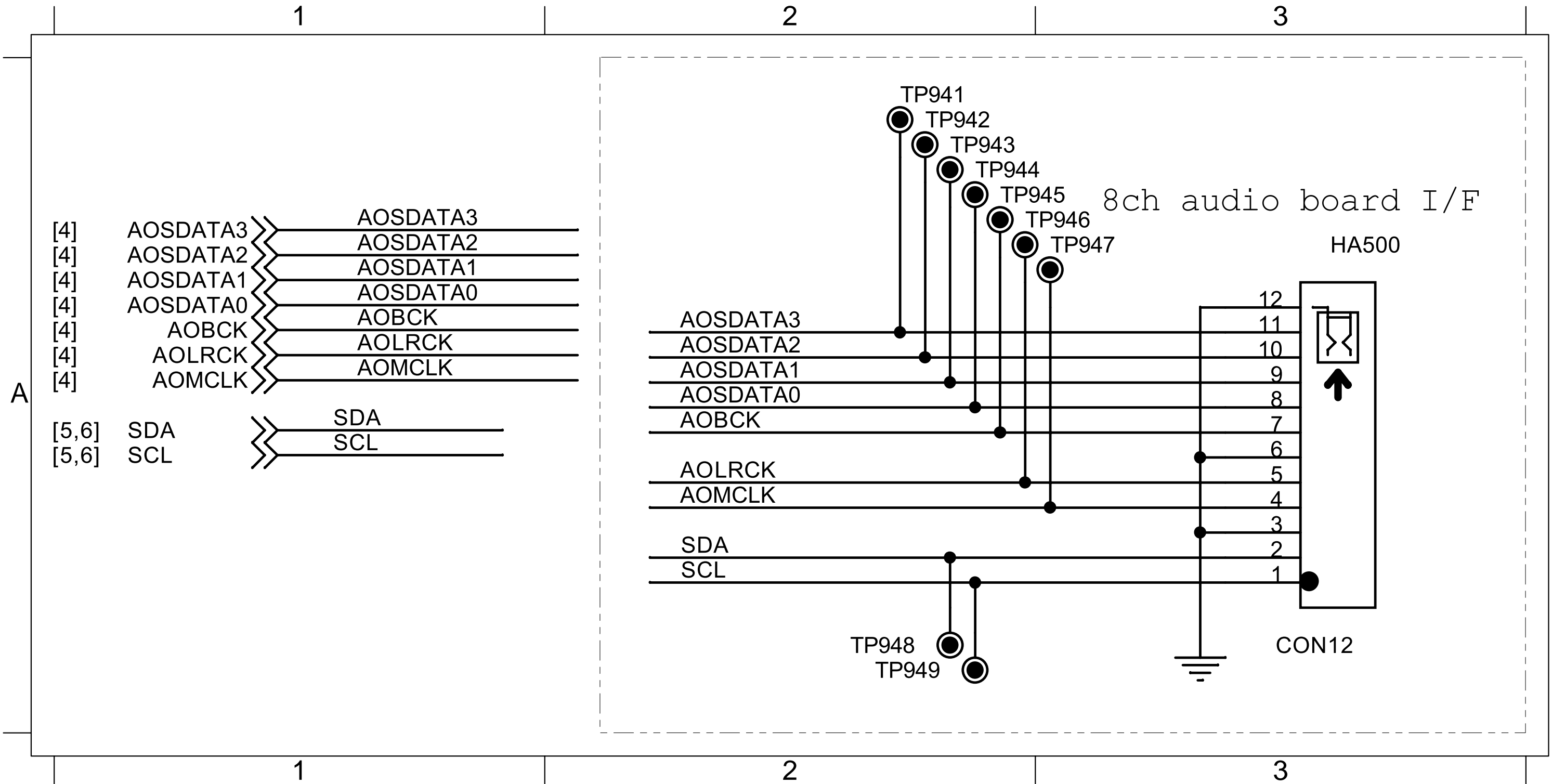

CIRCUIT DIAGRAM (ten)

C700	B1	C704	A2	C708	A2	C713	B2	C905	B2	R498	A3	R502	A2	R506	A1	R510	A1	R514	A3	R518	A1	R522	A1	R526	B2	R536	B3	R544	B3	Y302	B1
C701	A1	C705	A2	C709	A2	C714	B2	FB700	A2	R499	A3	R503	A2	R507	A1	R511	A1	R515	A3	R519	A1	R523	A2	R531	B1	R537	B1	R547	B3		
C702	A1	C706	A2	C711	A1	C715	B1	FB701	A1	R500	A2	R504	A3	R508	A1	R512	A1	R516	A1	R520	A1	R524	A1	R534	B3	R538	B3	RN351	B3		
C703	A1	C707	A2	C712	A1	C716	B1	P503	A3	R501	A2	R505	A1	R509	A1	R513	A1	R517	A3	R521	A3	R525	B1	R535	B3	R542	B2	U701	A1		

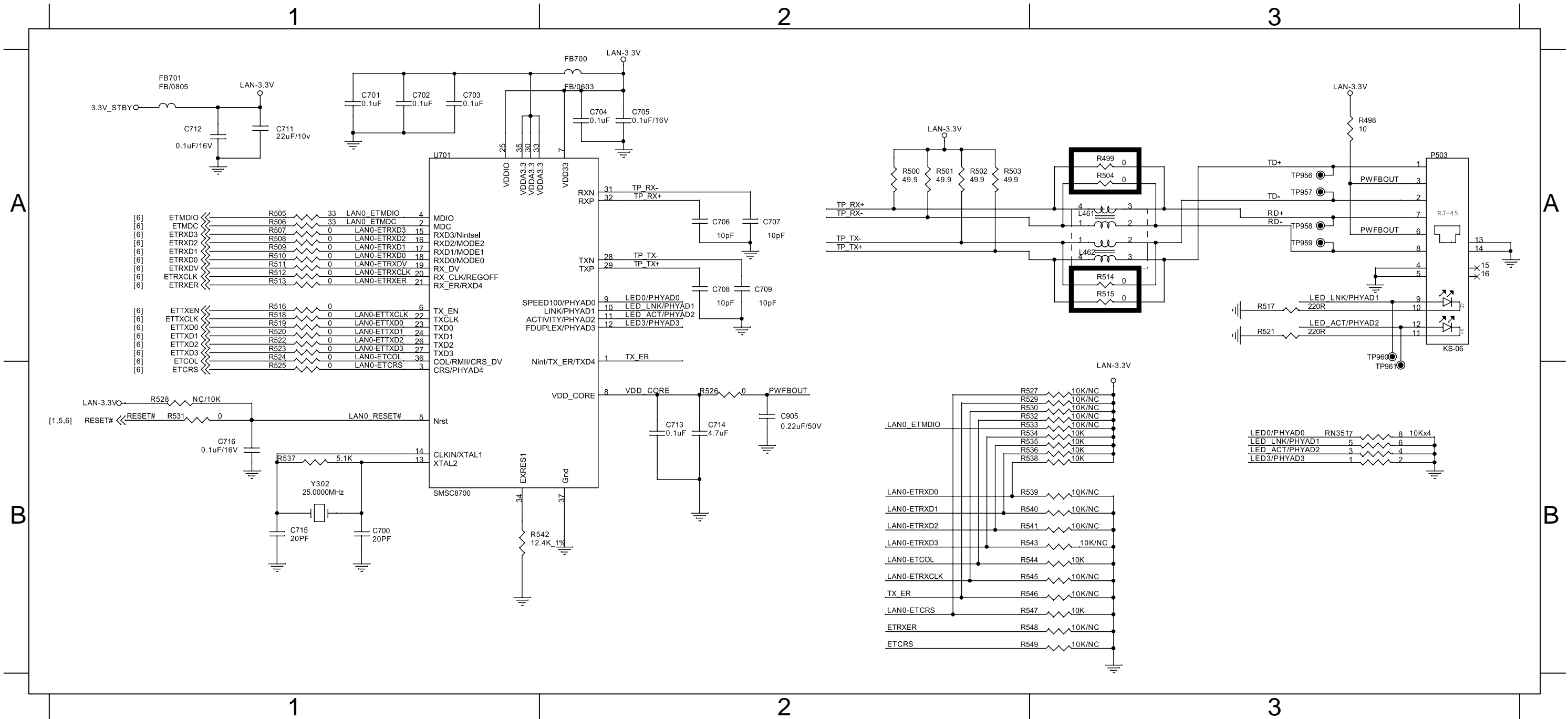

CIRCUIT DIAGRAM (eleven)

C801 A2	C808 A3	C815 B1	C822 B1	C833 B3	C842 B3	C918 A2	C930 C1	J802 B1	Q505 C2	R550 A1	R561 A3	R573 B3	R580 B3	R589 B1	R595 C1	R601 C3	R607 C3	R613 C2	R619 C2
C802 A3	C809 A1	C816 B1	C826 B1	C834 B3	C901 A1	C923 A2	C931 C2	L456 C2	Q506 C4	R555 A1	R565 B3	R575 B3	R581 B3	R590 B1	R596 C1	R602 C3	R608 C4	R614 C3	R620 C2
C803 A2	C810 B3	C817 B1	C827 B1	C835 B3	C902 A2	C924 A2	C932 C3	L457 C4	Q507 C3	R556 A3	R566 B3	R576 B3	R582 B3	R591 C1	R597 C2	R603 C1	R609 C4	R615 C2	
C804 A2	C811 B1	C818 B1	C830 B3	C836 B3	C903 A2	C927 B1	C933 C3	L458 C3	Q508 C3	R557 A3	R567 B1	R577 B2	R583 B3	R592 C1	R598 C3	R604 C2	R610 C3	R616 C1	
C805 A3	C813 B1	C819 B1	C831 B3	C837 B3	C916 A2	C928 B1	C934 C1	Q503 C2	Q509 C2	R558 A3	R568 B1	R578 B3	R584 B3	R593 C1	R599 C1	R605 C2	R611 C2	R617 C1	
C807 A2	C814 B1	C820 B1	C832 B3	C838 B3	C917 A2	C929 C2	J800 A3	Q504 C3	Q510 C2	R560 A1	R572 B3	R579 B3	R588 B1	R594 C1	R600 C1	R606 C3	R612 C2	R618 C3	

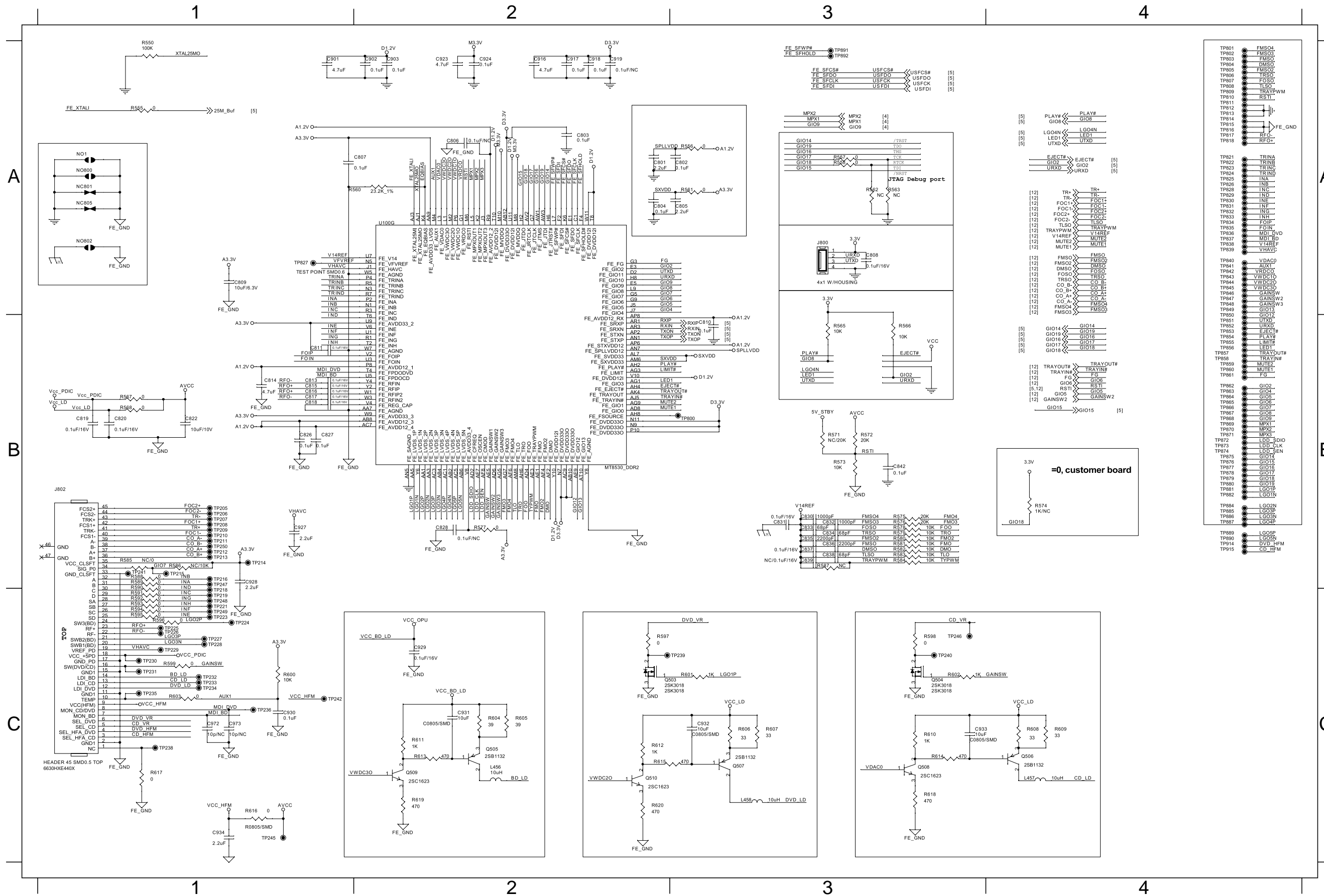

CIRCUIT DIAGRAM (twelve)

C935 A1	C939 A3	C943 B2	C947 B2	C952 C2	CB7 C1	CE15 B2	FB729A1	J906 A3	R624 A3	R628 A2	R640 B2	R645 C2	R651 C1	R657 C1	R661 C2	R674 C2	U900 A2
C936 A2	C940 A3	C944 B3	C948 B3	C953 C1	CE12 A2	CE16 C1	FB730A1	R621 A1	R625 A1	R630 C2	R641 B2	R646 C1	R654 C2	R658 C2	R662 C2	R675 C2	U902 C1
C937 A1	C941 A3	C945 B3	C950 B1	C955 B1	CE13 A1	CE17 B1	FB731C1	R622 A1	R626 A2	R634 A1	R642 B2	R648 C2	R655 C2	R659 C2	R664 C2	R683 A1	U906 C2
C938 A3	C942 A2	C946 B3	C951 C1	CB6 A1	CE14 A1	FB728A1	J900 A3	R623 A2	R627 A2	R639 B1	R643 C2	R650 C2	R656 C2	R660 C1	R671 B2	R684 A1	

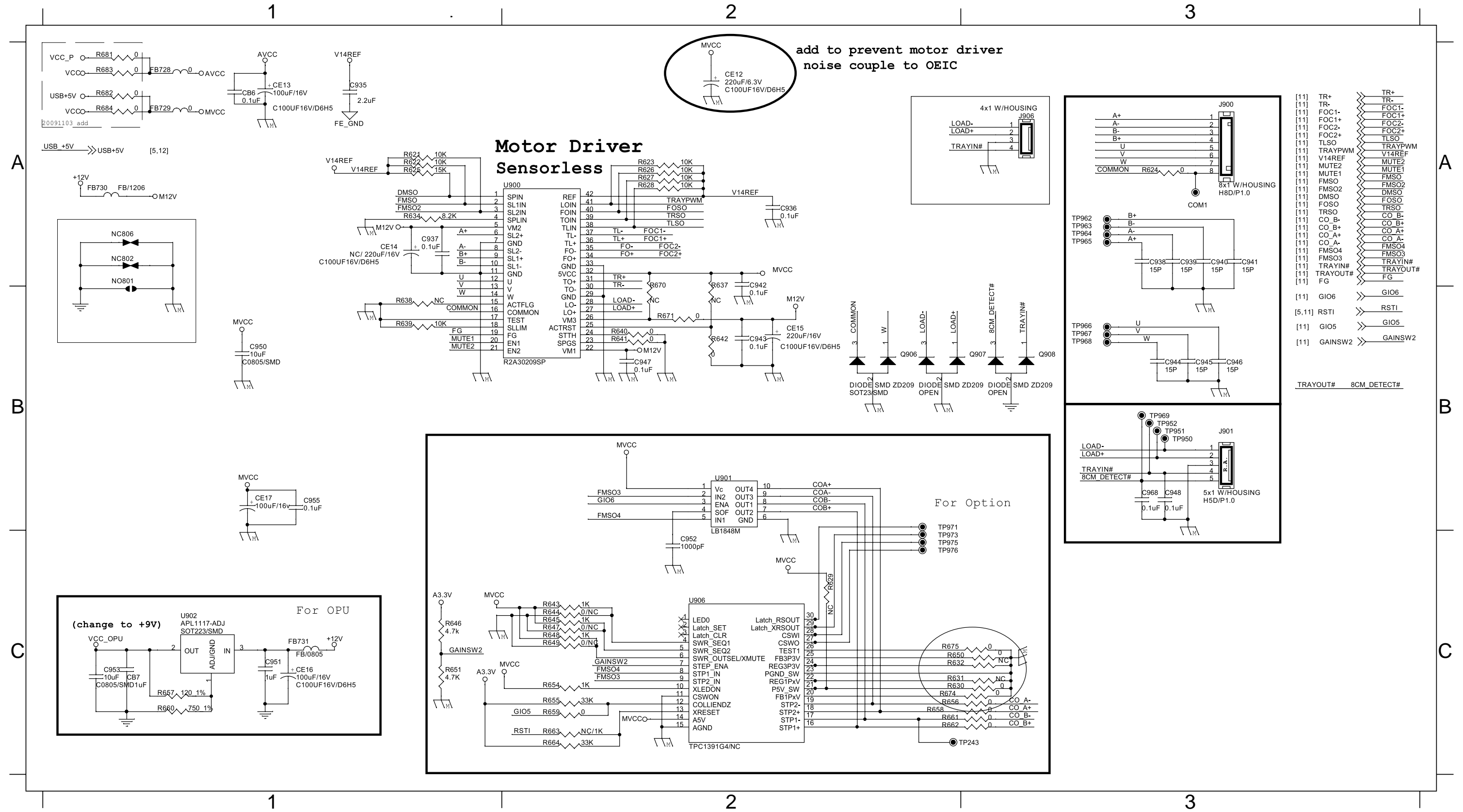

PCB LAYOUT - TOP VIEW

C831	A1	C148	C1	C232	D2	C335	C3	C463	B3	C715	D4	C937	A1	C952	A1	CB2	D3	CE19	D1	CN4	D2	FB724	A2	J355	D2	L458	B1	Q518	D1	R203	C2	R317	C3	R375	A2	R455	C3	R499	C3	R512	D4	R537	D4	R584	B1	R603	B1	R654	A1	RN102B1	U100	C2	U906	A1
C1	A3	C149	B1	C233	D2	C350	B2	C464	B3	C716	C3	C938	C1	C953	D1	CB5	C3	CE2	B3	D450	B3	FB728	C1	J800	A3	L459	D1	Q519	D1	R204	D2	R319	C3	R376	A2	R461	A3	R500	C3	R513	D4	R542	C3	R588	B2	R607	B1	R656	A1	RN103B1	U101	B1	U907	D1
C129	C1	C156	C1	C236	D2	C366	B2	C465	B3	C808	B3	C939	C1	C955	A1	CB7	C1	CE20	D1	D451	B3	FB729	A1	J802	B1	P501	A3	Q6	D1	R205	C2	R320	B2	R377	A2	R467	B3	R501	C3	R514	C2	R544	C3	R589	B2	R610	B1	R657	C1	RN104B1	U102	C1	U908	A3
C138	B1	C16	C3	C237	D2	C367	B2	C466	B3	C818	B2	C940	C1	C956	A3	CE1	A3	CE21	D1	D454	B3	FB730	D1	J900	B1	P502	C3	R100	C1	R24	D1	R335	B3	R381	A2	R470	B3	R502	C2	R515	C2	R550	B2	R590	B2	R611	A1	R658	A1	RN105C1	U103	C1	Y300	B1
C139	B1	C19	D1	C3	C3	C370	B2	C501	C3	C834	A2	C941	C1	C960	D1	CE10	A2	CE22	D2	D455	A3	FB731	D1	J903	A2	P503	D3	R101	B1	R304	B1	R336	B3	R394	B2	R473	D2	R503	C2	R516	C3	R555	B2	R591	B2	R616	A1	R660	D1	RN200D2	U201	D2	Y301	B3
C140	C1	C2	B3	C31	C3	C374	B1	C700	D4	C838	A2	C942	A2	C961	D1	CE11	A2	CE23	A3	D456	D1	FB733	D1	J906	C1	Q504	B1	R102	B1	R305	B1	R360	C3	R40	C3	R475	D1	R504	C3	R518	D4	R557	A2	R592	B2	R617	A1	R661	A1	RN201D2	U202	C2	Y302	D2
C141	C1	C221	D2	C312	C2	C375	B1	C705	C3	C906	B3	C943	A1	C962	D2	CE12	A1	CE24	A3	FB304	B3	FB734	D1	L3	D1	Q505	B1	R103	C1	R308	C3	R363	B1	R401	C2	R476	D1	R505	C3	R519	D4	R559	B3	R593	A2	R623	A2	R662	A1	RN202D2	U3	C3	ZD2	A2
C142	C1	C222	D2	C319	B1	C376	B1	C706	C3	C927	B2	C944	C1	C965	A3	CE13	C1	CE25	D1	FB312	B2	FB738	A3	L450	B3	Q506	B1	R104	C1	R309	C3	R365	B1	R407	C2	R482	D4	R506	C3	R520	D4	R560	B2	R594	A2	R626	A2	R671	A2	RN203D2	U300	C3		
C143	C1	C223	D2	C32	D1	C377	B1	C707	C3	C928	B1	C945	C1	C967	A3	CE14	A1	CE26	C1	FB501	C3	FB743	D4	L451	B3	Q507	B1	R105	C1	R310	C3	R367	B3	R42	C1	R483	D4	R507	D2	R522	D4	R565	A3	R595	B1	R628	A2	R673	D4	RN204D2	U351	D2		
C144	C1	C228	D2	C322	B1	C455	C3	C708	C2	C932	B1	C946	C1	CB1	D4	CE15	A1	CE6	D1	FB701	C2	HA500	A3	L453	A3	Q511	A3	R108	D1	R312	B2	R368	B3	R423	A3	R484	D4	R508	D2	R523	D4	R566	A3	R596	B1	R639	A1	R683	D1	RN205D2	U5	C3		
C145	C1	C229	D2	C326	B2	C456	B3	C709	C2	C933	B1	C947	A2	CB12	D1	CE16	D1	CE8	C3	FB705	D3	HA501	A2	L455	B3	Q512	A3	R200	D2	R313	C3	R369	B3	R424	A3	R495	A3	R509	D2	R524	C3	R578	A1	R597	B1	R643	A1	R684	A2	RN350D2	U6	D1		
C146	C1	C230	D2	C33	D1	C459	A3	C711	C3	C934	B1	C950	A2	CB13	D2	CE17	A1	CE9	C1	FB710	C3	J300	C2	L456	B1	Q513	B3	R201	D2	R315	C3	R370	B3	R427	B1	R496	A3	R510	D2	R525	C3	R579	A1	R598	B1	R645	A1	RN100C1	RN351C3	U701	D4			
C147	C1	C231	D2	C334	C3	C460	A3	C712	C3	C936	A1	C951	D1	CB14	C1	CE18	D1	CN203D4	FB712	D1	J351	A3	L457	B1	Q514	B3	R202	D2	R316	C3	R373	A2	R43	D1	R497	A3	R511	D4	R531	C3	R583	A1	R600	B1	R648	A1	RN101C1	U1	B3	U902	D1			

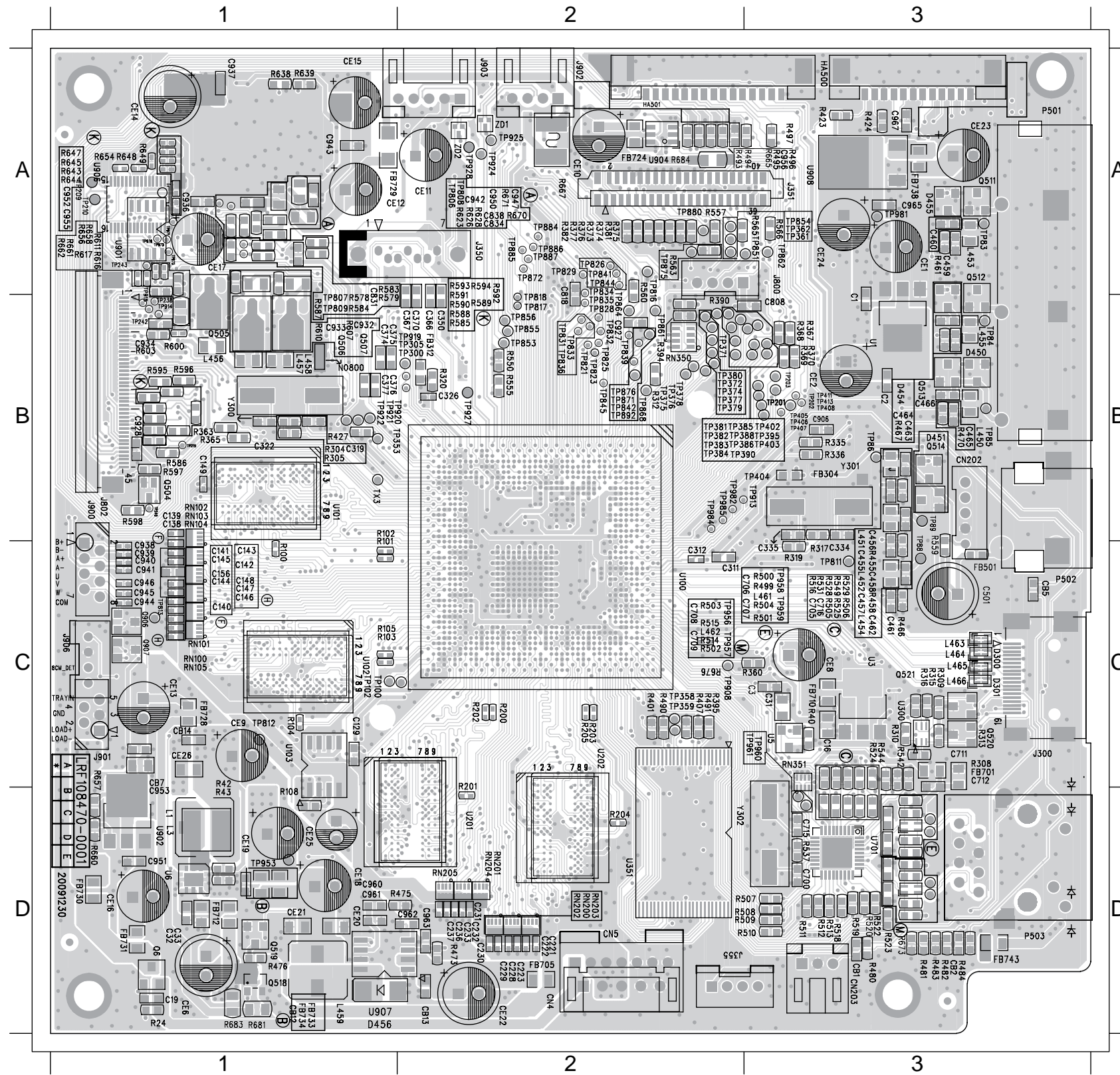

PCB LAYOUT - BOTTOM VIEW

C100 C2 C113 B1 C126 C2 C151 C2 C208 D2 C224 D2 C304 C2 C329 B2 C363 A2 C397 C2 C409 C1 C422 C1 C803 B2 C820 B1 C903 C2 C930 B1 CB8 A2 FB309B1 FB360D3 Q402 A3 R26 D1 R322 C3 R355 C2 R412 B3 R479 D1 R538 D3 R581 A2 R614 B1 R641 A1 U905 A2
C101 C1 C114 B1 C127 C1 C152 C1 C209 C2 C225 D2 C306 C2 C330 B2 C364 B2 C398 B2 C410 C2 C423 C2 C804 C1 C822 B1 C905 D3 C931 B1 CB9 A2 FB310B1 FB361C2 Q503 B1 R27 D1 R323 D3 R358 B2 R415 B3 R485 C3 R547 D3 R582 A2 R615 B1 R642 A1
C102 C2 C115 C1 C128 C2 C153 D1 C210 D2 C226 C2 C308 C2 C332 B1 C368 B1 C399 B2 C411 C2 C424 C2 C805 C1 C826 B1 C907 A3 C935 B2 D201 D1 FB311B1 FB700D3 Q508 A1 R28 D1 R326 C2 R359 B2 R416 A3 R486 A2 R556 B2 R599 B1 R618 B1 R646 A1
C103 C1 C116 C1 C130 B1 C155 C2 C211 D2 C227 C2 C309 C3 C336 C3 C386 C2 C4 B1 C412 C1 C5 C1 C807 B1 C827 B1 C908 A3 C948 C1 D202 C3 FB350A2 FB717C2 Q509 A1 R29 D1 R330 B3 R378 A3 R417 A3 R487 A2 R558 A2 R6 D1 R619 B1 R650 A1
C104 C2 C117 B1 C131 C2 C20 D1 C212 C2 C23 C3 C310 C3 C351 D2 C388 C2 C400 B2 C413 C1 C6 D1 C809 B2 C830 A1 C909 A3 C966 D1 FB100C1 FB351B2 FB718A2 Q510 A1 R30 C3 R331 B3 R393 C2 R418 A3 R488 A2 R561 C1 R601 B1 R620 B1 R651 A1
C105 B2 C118 C1 C132 C1 C200 D1 C213 C1 C234 C2 C313 C2 C353 B2 C389 D2 C401 C2 C414 C1 C701 D3 C810 B2 C832 A1 C910 A3 C970 C1 FB352B2 FB719C2 Q517 D3 R300 C2 R332 B3 R397 C2 R419 C2 R489 A2 R567 B1 R602 B1 R621 A1 R655 A2
C106 C2 C119 B1 C133 B1 C201 C2 C214 D1 C235 D2 C315 C2 C354 B2 C390 B1 C402 C1 C415 C2 C702 D3 C811 B2 C833 A1 C911 A3 C971 D3 FB301C3 FB353A2 FB722C1 Q7 D1 R302 C2 R333 B3 R398 D3 R425 B2 R498 D3 R568 B1 R604 B1 R622 A1 R659 A2
C107 C2 C120 B1 C134 D2 C202 C2 C215 C2 C238 D1 C316 C2 C355 D2 C391 C1 C403 C2 C416 C2 C703 D3 C813 A2 C835 A1 C916 C2 C975 D1 FB302C2 FB354A2 FB723C1 Q8 C3 R303 C3 R334 B3 R399 D3 R426 B1 R517 D3 R572 A2 R605 B1 R624 C1 R664 A2
C108 C1 C121 B1 C135 B1 C203 C2 C216 C2 C239 D2 C317 C2 C356 B2 C392 B1 C404 C2 C417 C2 C704 D3 C814 C1 C836 A1 C917 B2 CB10 D1 FB303C3 FB355B1 FB725A2 Q9 C3 R306 C3 R35 C3 R400 C2 R471 D1 R521 D3 R573 A2 R606 B1 R625 A1 R672 D1
C109 B1 C122 B1 C136 C1 C204 D1 C217 D2 C27 C3 C318 C2 C357 B2 C393 C3 C405 C1 C418 C2 C713 D3 C815 A2 C837 A1 C918 C1 CB11 D1 FB305B2 FB356B2 FB742D3 Q901 B1 R31 C3 R350 D2 R402 C2 R472 D1 R526 D3 R575 A1 R608 B1 R627 A1 R674 A1
C110 C1 C123 C1 C137 C2 C205 D2 C218 C2 C30 C3 C321 C2 C358 C2 C394 C3 C406 B2 C419 C2 C714 D3 C816 A2 C842 B2 C923 B2 CB3 A2 FB306C2 FB357B2 Q300 C3 R106 C2 R314 C3 R351 D2 R404 D2 R474 D1 R534 D2 R576 A1 R609 B1 R630 A1 R675 A1
C111 B1 C124 C1 C15 C3 C206 D2 C219 C2 C300 C2 C325 A2 C359 A2 C395 C2 C407 C2 C420 C1 C801 C1 C817 A2 C901 C1 C924 B2 CB4 A2 FB307C3 FB358C2 Q301 D3 R109 D1 R32 C3 R352 C2 R405 D2 R477 D1 R535 D2 R577 B1 R612 B1 R634 A1 R677 B3
C112 C2 C125 C2 C150 C1 C207 D2 C220 C2 C302 C2 C328 B2 C361 B1 C396 C2 C408 C2 C421 C1 C802 C1 C819 B1 C902 B1 C929 B1 CB6 C1 FB308B1 FB359C2 Q401 B3 R206 C2 R321 C3 R354 C2 R41 D1 R478 D1 R536 D2 R580 A2 R613 B1 R640 A1 U900 A1

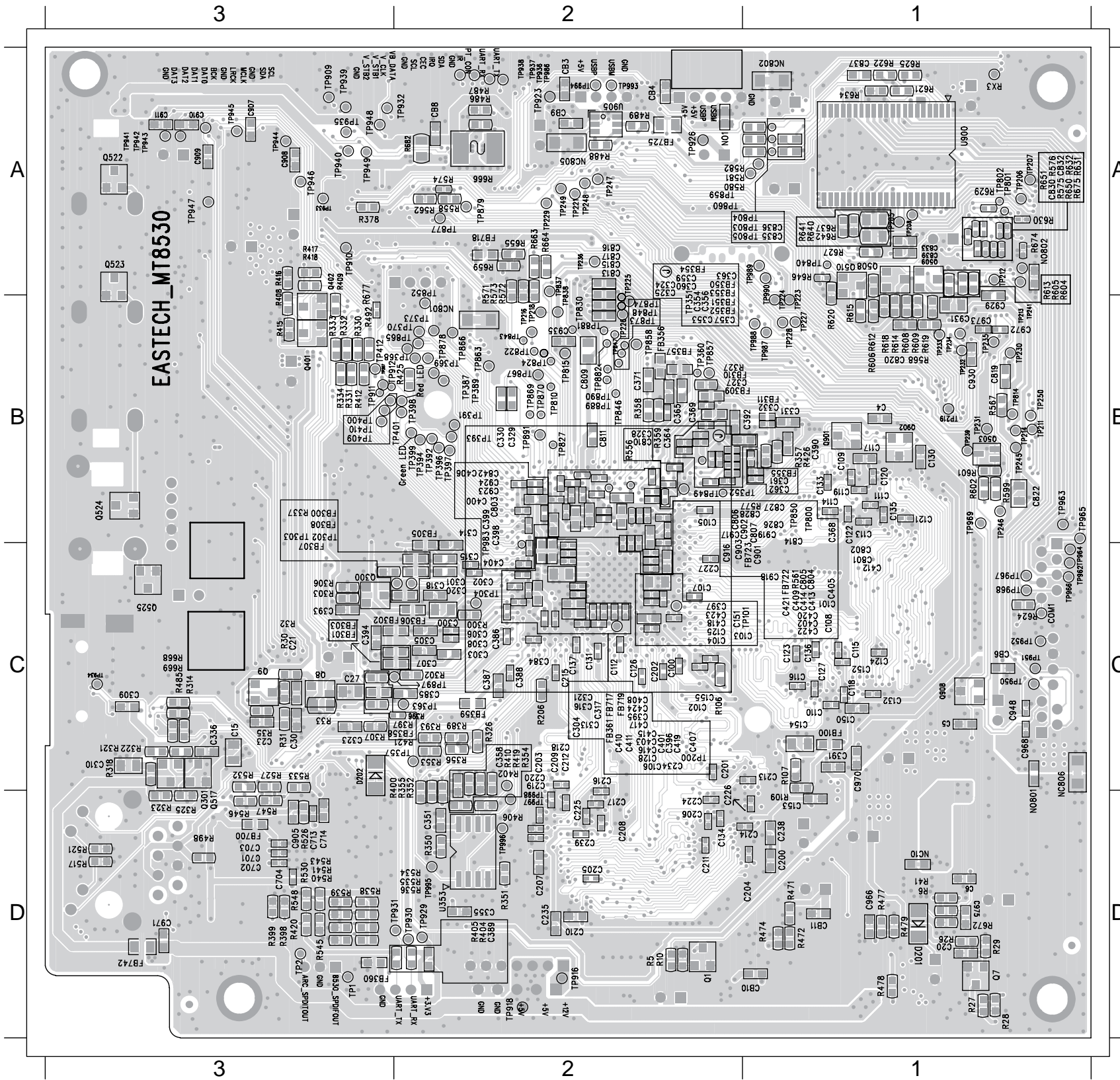

TOUCH BOARD

TABLE OF CONTENTS

Circuit Diagram..... 10-2
PCB Layout Top View & Bottom View..... 10-3

CIRCUIT DIAGRAM

10 - 2

10 - 2

C1 A2 C2 A1 C4 A3 C6 B1 C9 B3 D1 A3 R10 B1 R12 B1 R14 B2 R2 A2 R4 A2 R6 A3 R8 B2 U1 A2
 C10 B3 C3 A2 C5 A3 C8 B2 CN1 A3 R1 A3 R11 B1 R13 B1 R15 B2 R3 A3 R5 A3 R7 A3 R9 B1

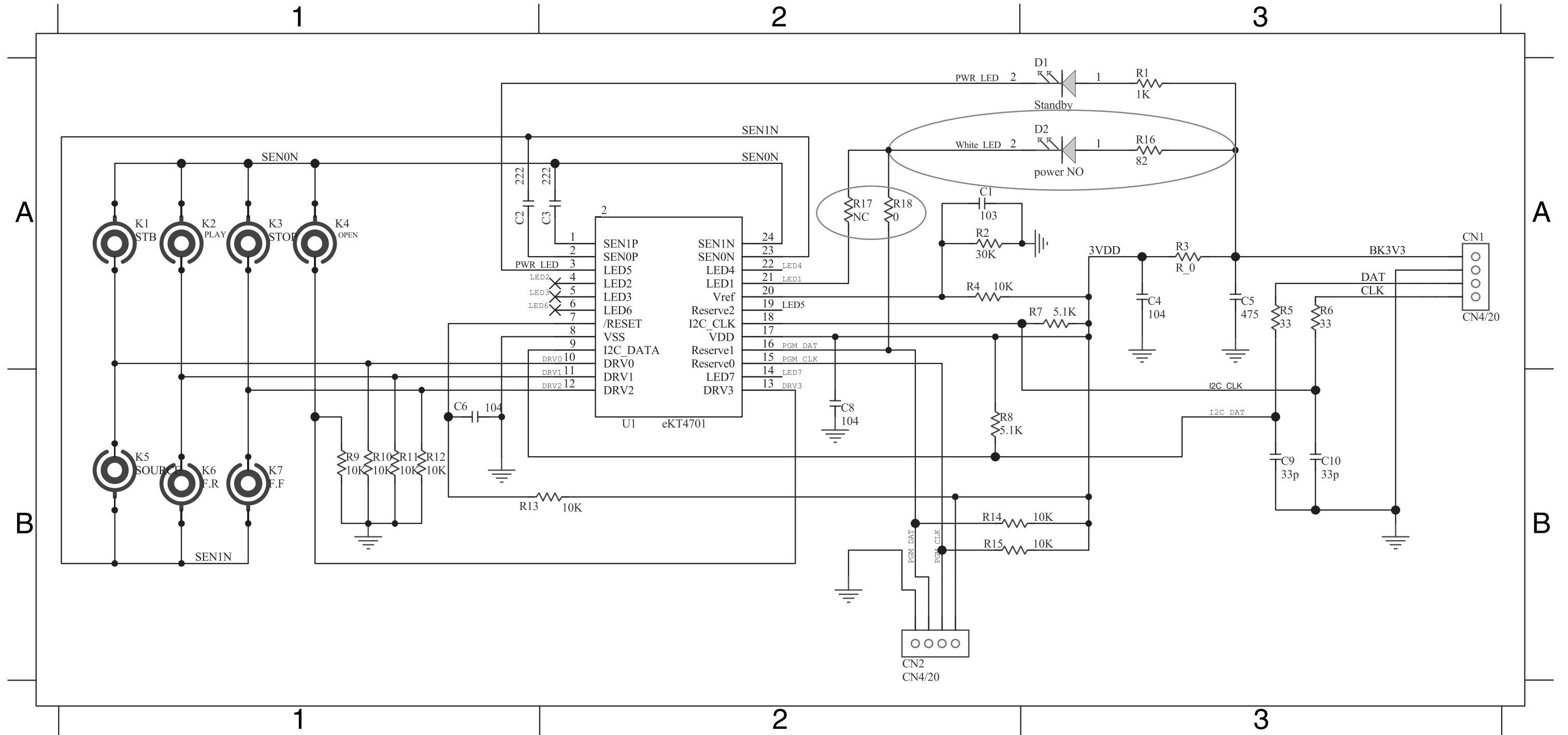

PCB LAYOUT - TOP VIEW

10 - 3

10 - 3

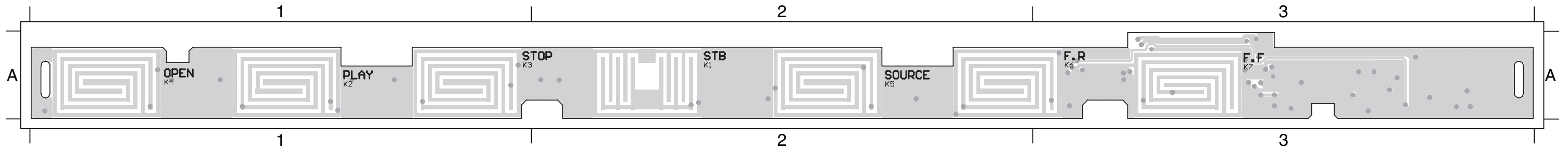

PCB LAYOUT - BOTTOM VIEW

- C1 A3 C2 A3 C4 A3 C6 A3 C9 A3 D1 A2 R10 A3 R12 A3 R14 A3 R2 A3 R4 A3 R6 A3 R8 A3 U1 A3
- C10 A3 C3 A3 C5 A3 C8 A3 CN1 A3 R1 A2 R11 A3 R13 A3 R15 A3 R3 A3 R5 A3 R7 A3 R9 A3

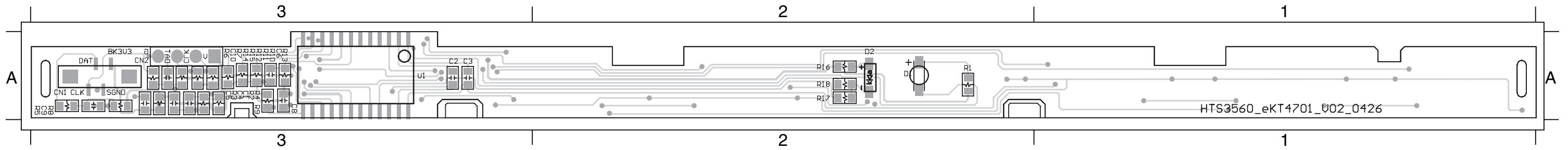

Mechanical Exploded View

11 - 1

11 - 1

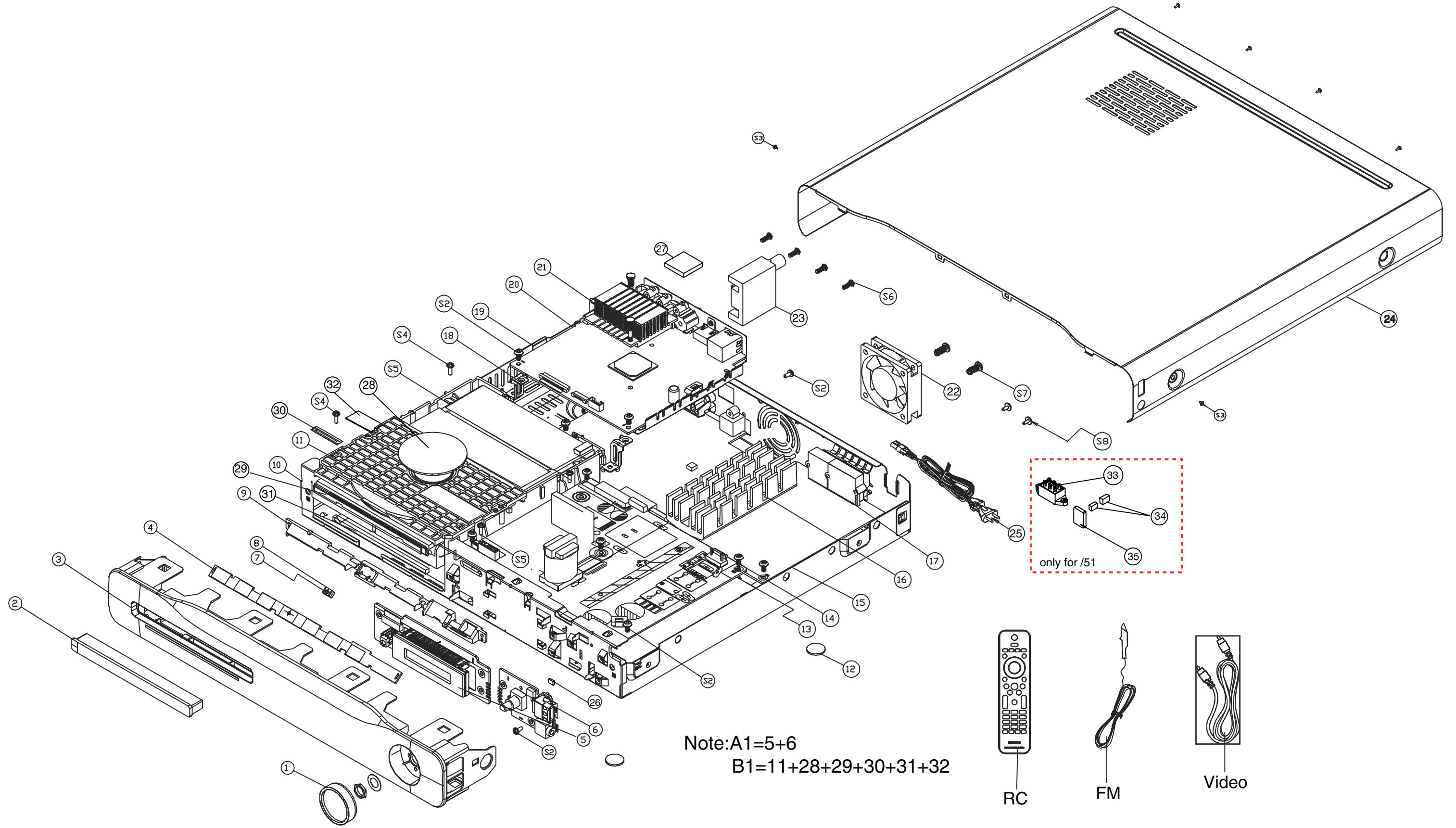

Note: A1=5+6
B1=11+28+29+30+31+32

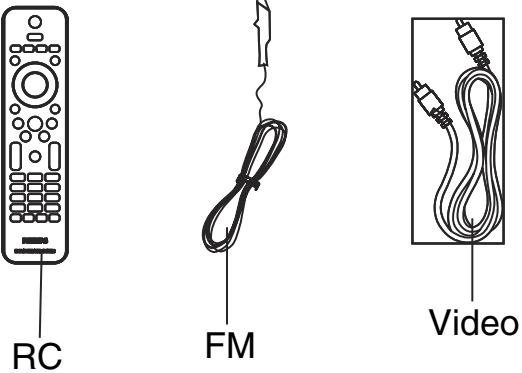

REVISION LIST

Version 1.0

*Initial release

Version 1.1

*HTS3560/51 combine with HTS3560/12/98

Version 1.2

*Add HTS3560/78

Version 1.3

*Add HTS3560X/78